

Southern College
of
Technology

Southern College of Technology

Southern
College of
Technology

Technician's Log

Volume 45 1993-1994

©Copyright 1994 by Kassia Cato, Editor, *Technicians Log*, Southern College of Technology. All rights reserved. No part of this publication may be reproduced or transmitted by any means without the expressed permission of the editor or the Director of Student Activities.

RIGHT HERE

Right here, Right now is what defines us. It serves to make us who we are and who we will become. The future is not promised to any of us, the only obligation that any of us truly have is to the present. If we cannot find a way to take control of the present the future will indeed be dismal. Right now we have to learn that regardless of the future that we have planned for ourselves, events right now can rapidly change those plans.

In this country, in this state and even in our own local communities we are seeing how events that are happening a whole world away have a bearing on us right here.

From a war in Bosnia-Herzegovina to a small village in Norway, global events are more important now than ever before. In the 90's we are learning to become information junkies. We have 24 hour TV news, Talk Radio, Newspapers, Magazines and The Internet all designed to keep us abreast of the days events in seconds.

Right now we live in a world of Personal Digital Assistants, Laptops, Notebooks, Computers, CD-ROMS, Networks, Modems, and any other device that we can access information RIGHT NOW.

Right now we are preparing ourselves to live and work in a changing world where "The Information Superhighway" promises to change our world forever. Events that take place on the other side of the world have the power to make or break businesses and careers right here in Marietta.

Right here at Southern Tech is where we start to formulate concrete career goals.

Right Now Atlanta prepares for an Olympic games that only time will tell will be successful and make Atlanta a truly International city.

The classes that we take right now in 10, 15 or 20 years may not seem important in whatever career that we choose but to us they are important right now.

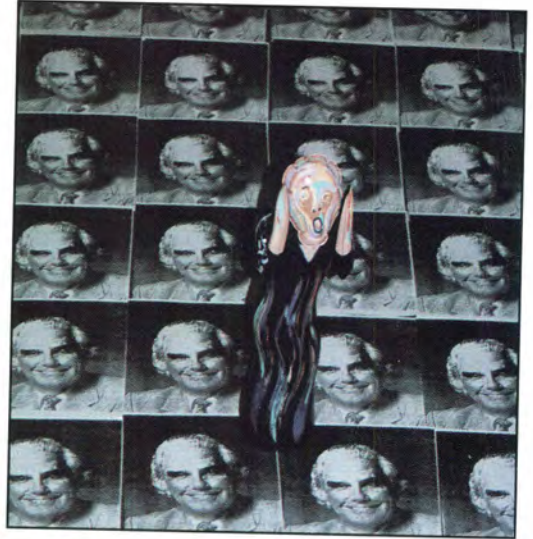

RIGHT NOW

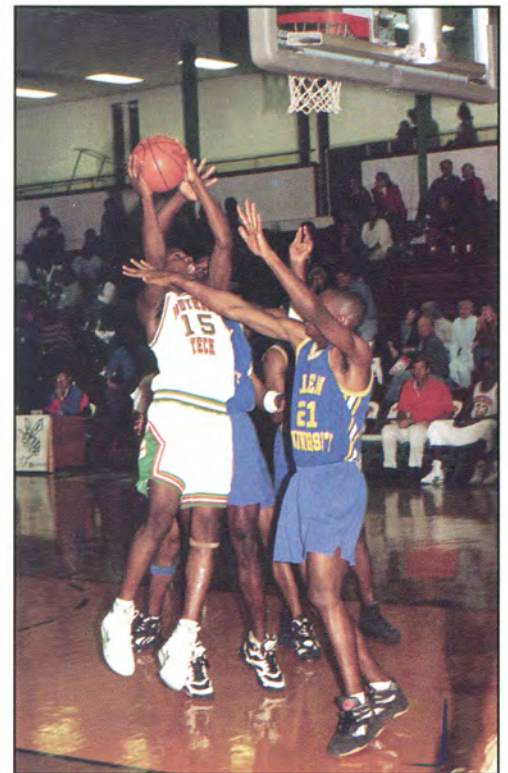

PEOPLE TO SEE



Hi, I would like to take classes here.

Before we start our academic career, and throughout our time here, we rely on certain people that are often overlooked. Without them the school could not function. So, if you have forgotten, here are the People To See at Southern Tech.



Money? What Money? I came here for money. Forms, not more forms!

We started our venture where most of you did, with the Registrar. You remember them, they were the ones that took your application and told you that first they needed your SAT scores and transcripts from your high school and other colleges you attended. Once we were admitted the fun really starts.



That's \$348 in overdue fees.

After being advised we were learned the art of patients as we found line after line, the first being to register. Later we learn how to register by modem or when the lines are shortest, like Saturday at 10:00 am. Sticker shock sent some of us to the Financial Aid Office, there we found a whole new set of forms to fill out and documents to have mailed to the school.



Is this enough for me to get a B.

Cash, check, money order, or letter of award in hand we ventured down to Norton Hall, not to sleep but to pay our fees. Pick a payment plan and find a line, just \$549.50 a quarter for most of us. But our spending was just beginning.

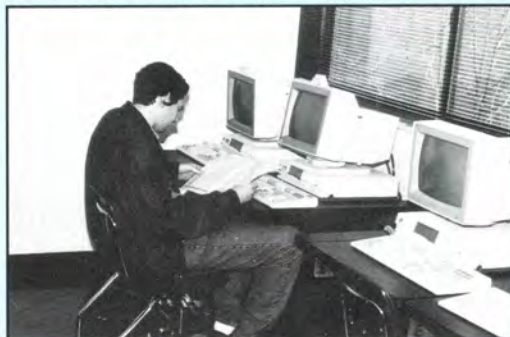

How do you turn this box on?



Can you put I'm over 21 on that?

Off to the Student Center where the bookstore waits for our dwindling reserves downstairs. Sticker shock from the new book price is only slightly less for a used one, when available. Pencils and leads and binders and aspirin and lab materials and manuals and thirty types of graph paper in one central location. And if you still have some money left you just have to get one of those Southern Tech shirts.



World War II didn't last this long.



...or you can use our easy installment plan. Do you have any collateral?



There you go now hon. I can give you some aspirin but I can't write you an excuse for yesterday.

When classes finally start we found a whole new group of people we needed to know. At the Student Center Info Desk we got our student ID. Then the Library added their stamp. And finally the Mac Labs add their seal of computing approval. We had arrived.



Fill this out and return it. We will be checking your references. We run a class

For some the daily journey was too far and we opted for the on-campus dorms. The school will hire some of us to work in different departments while we are students, requiring more forms and more documents. Others weary from the quest caught a cold or THE FLU and found aid and comfort with the Campus Nurse. Some sought extra circular activities to round off our experience and found that the Student Activities Office had the answer. And some of us got in trouble, or could not get a straight answer, and had to see Dean Smith.



Well I can program my VCR, what else do I need to know?

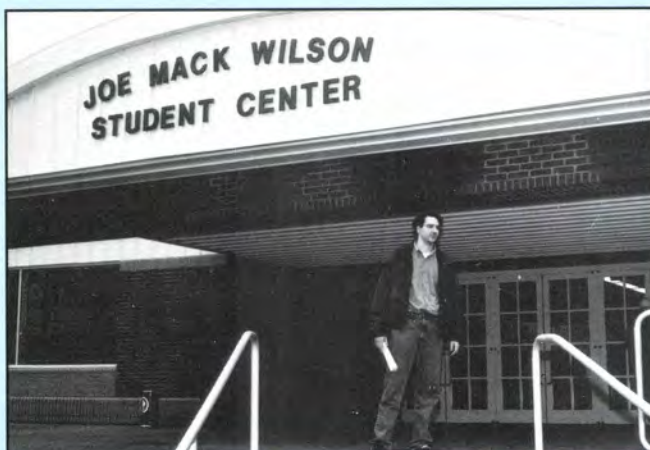

Preston Goforth is really a junior. He just played a freshman for this section.



No one knows student activities like Vicki.



Now fill these out in triplicate, and bring back an item from group A and B. Make sure you sign the Loyalty Act.



Don't worry Dean Smith has only had to order one execution since I've been here.



This would insult Life students if they could read.

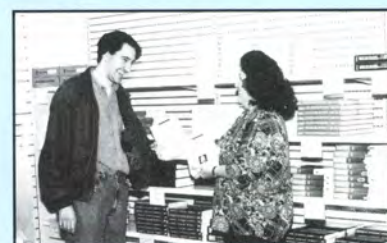

Now when you return this book we will give you half of what you paid for it.



Now don't make me use this pencil.

And for years we study and rely on their help never questioning their devotion. Finally the last office we go through is where we started, the Registrar. After all this time is it any wonder that we have to Petition to Graduate.

STUDENT LIFE

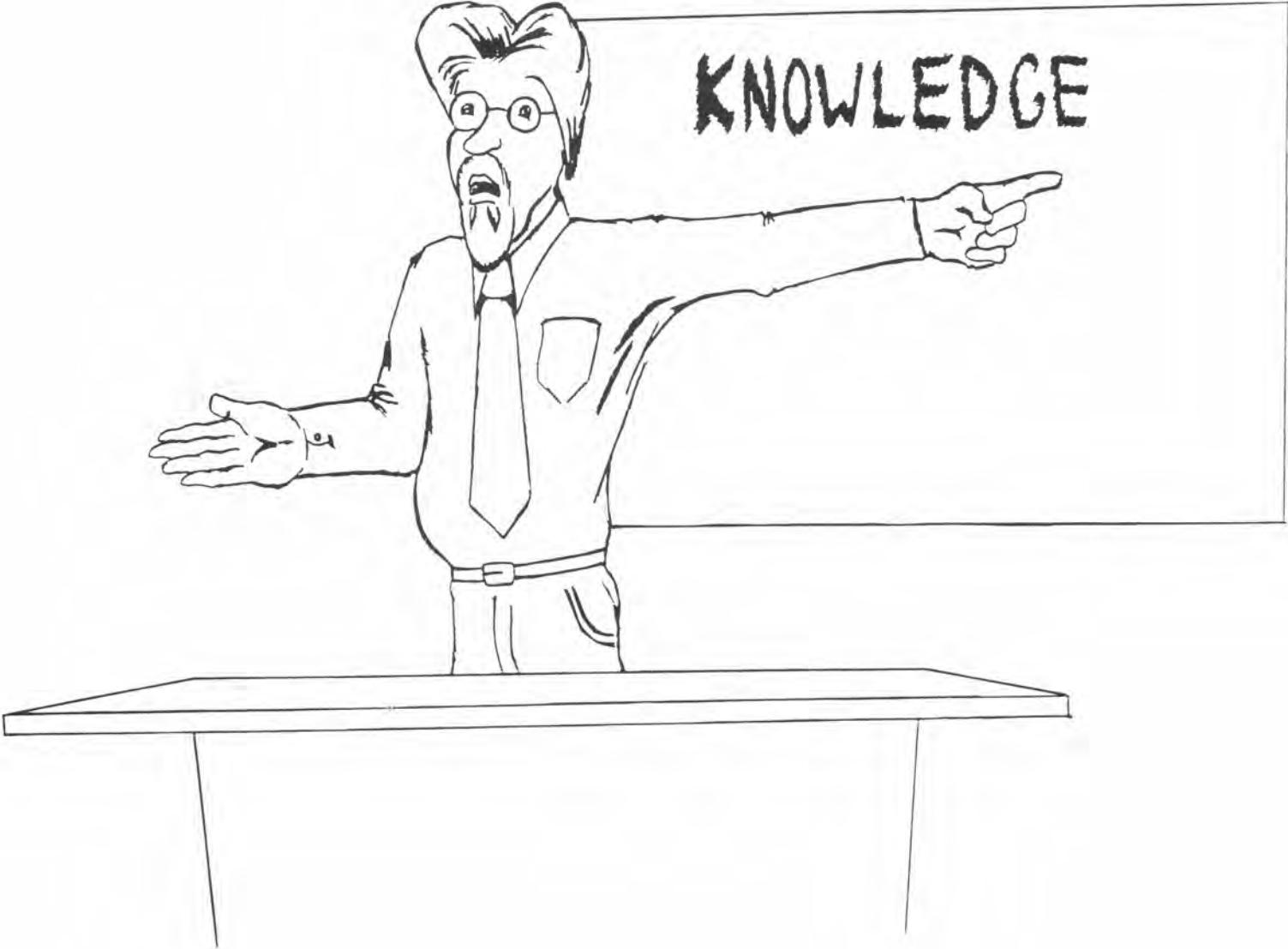



TAKE A LOOK AT PAST



Miss STI 1970, Miss Susan Perry, West Georgia College
Sponsored by Alpha Beta Sigma



Charles Smith Dean of Students



Tom Carmichael, Industrial Engineering Professor

Us Now PRESENT



Charles Smith, Vice President Academic Affairs



Mr. and Miss Southern Tech 1994, Johnny Bryant and Karen Bland



Tom Carmichael, Industrial Engineer Technology
Department Head

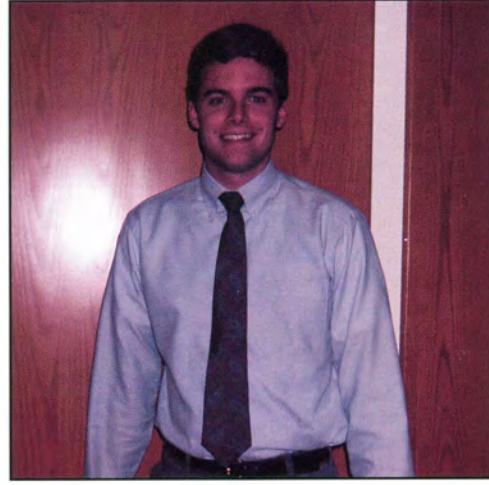
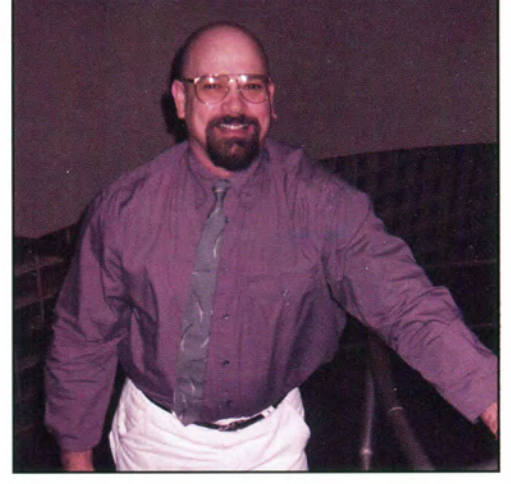
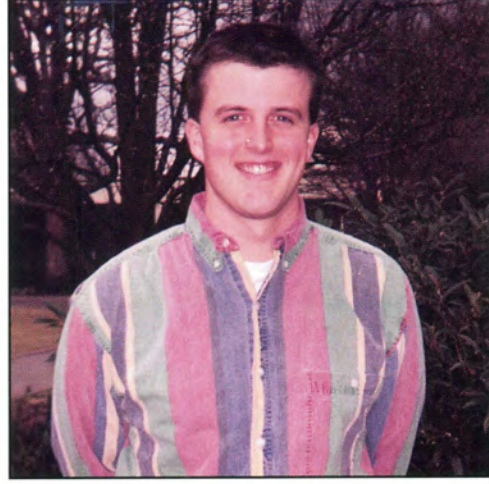
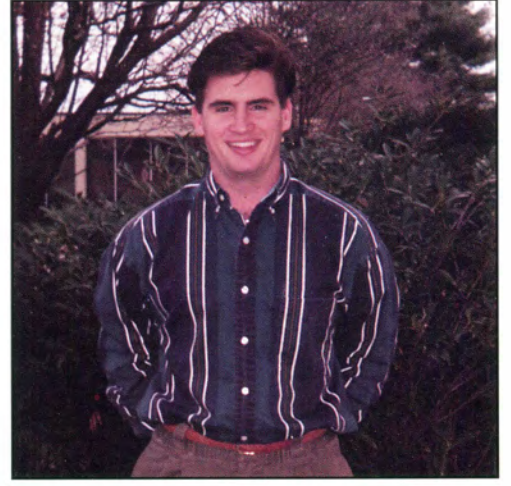
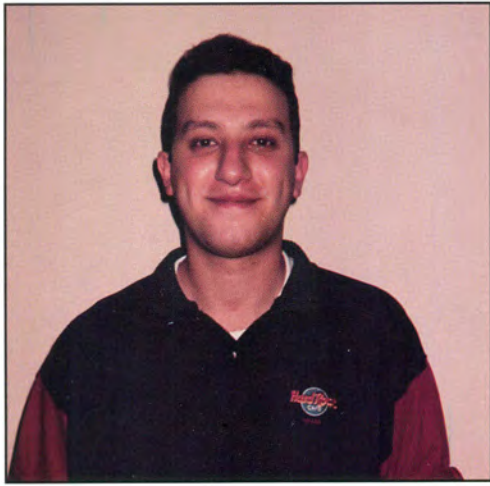



Homecoming was held for the first time in the Joe Mack Wilson Student Center ballroom. The intimate setting was perfect for the festivities. The Members of the 1994 Homecoming court were nominated by various student organizations. The 1994 Homecoming court included (left to right) Akram "Ike" Awaida, Bob Buhl, Andrew Butler, Wendy Harper, Jason Hodges, Charles Maurone, David "Archie" Nelson, John Newberry, Kevin Purcell, Mirhonda Studevart, Jennifer Waller, and Andre Willis.

The winners of the voting for Mr. and Ms. Southern Tech 1994 were Johnny Bryant and Karen Bland (pictured above). In addition to receiving a nifty crown or scepter, each received a \$150 scholarship. Additionally Mr. and Ms. Southern Tech 1993 each received the crown or scepter that they didn't receive in 1993 and so richly deserved.



HOME COMING '94

EATING HABITS

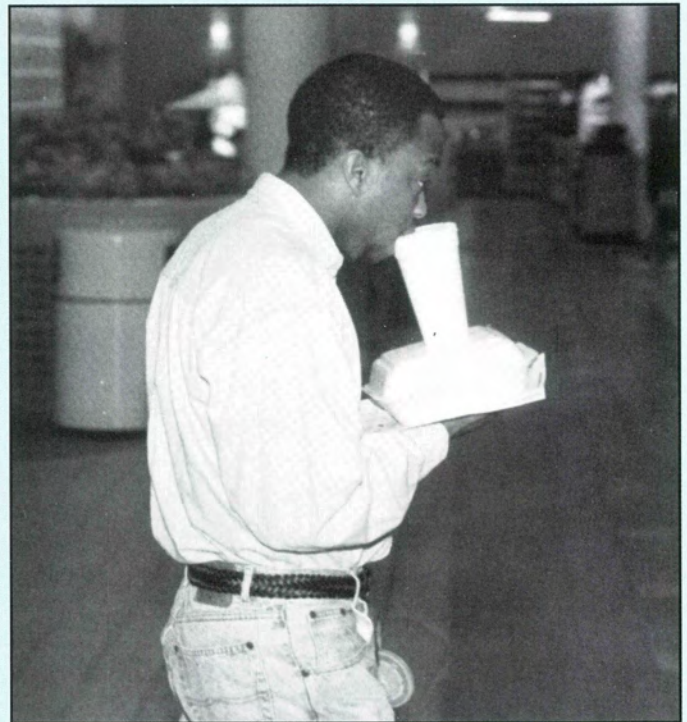
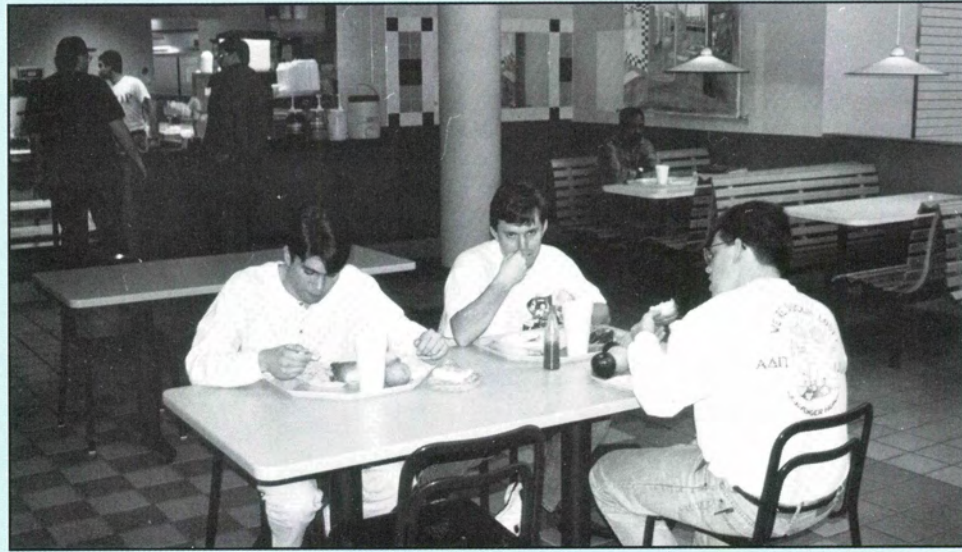

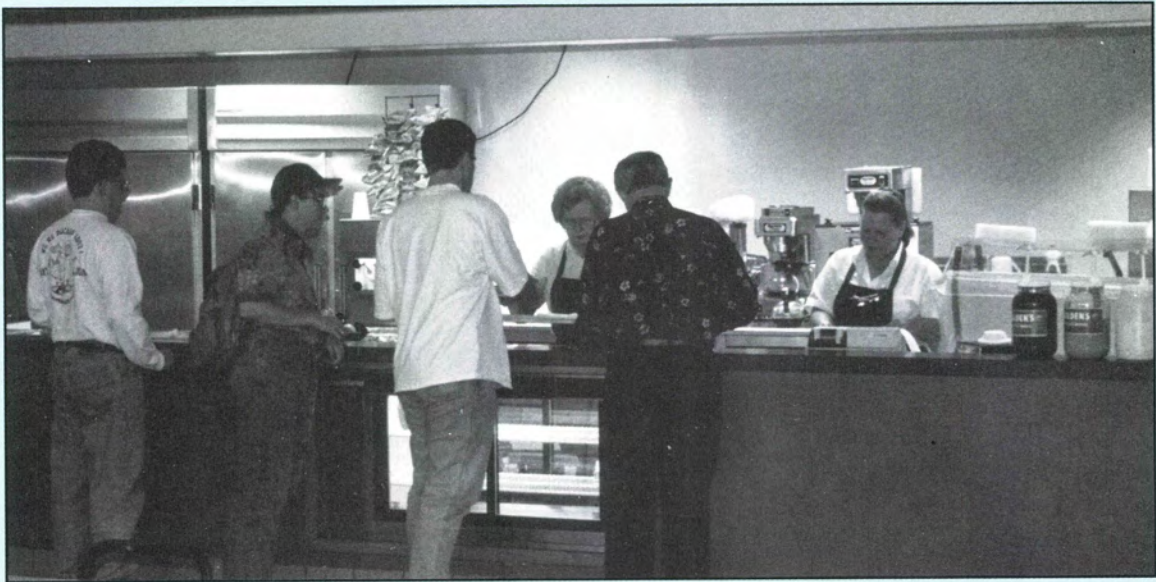
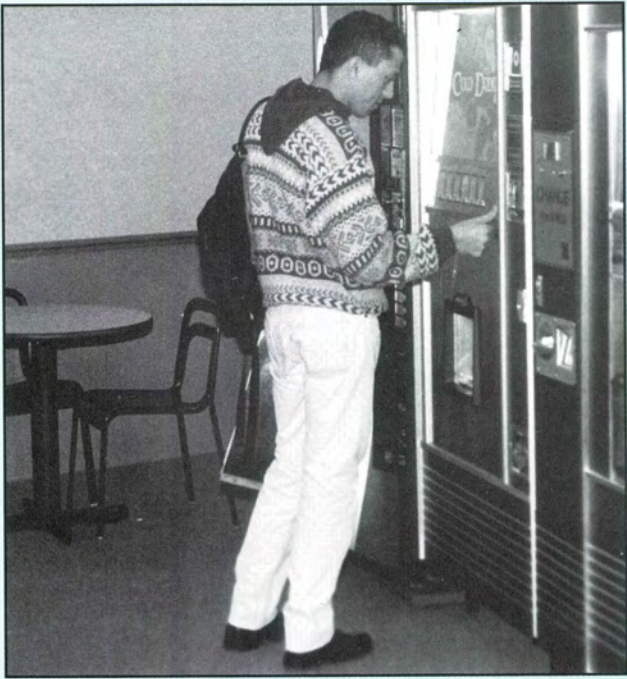

CAMPUS EVENTS

Life Vs. Sct

The annual contest between Southern Tech and Life College took on a new dimension this year. Hundreds of Sid on a Stick face masks were handed out to students and guests at the game. For the first time in the history of the rivalry, the Hornets defeated the marauding chiropractors 70-63.



Casino Night

Sponsored by C.A.B. this annual event gives students an opportunity to gamble with house money. Students started with \$25,000 and used whatever gambling skills they possessed to win the chance to take home many fabulous prizes.

Homecoming

The 1993-94 Homecoming Dance was held in the Student Center, people ate, drank and made merry at this annual campus festive occasion. The event included in addition to the standard dancing, a caricature artist and complimentary balloon animals.



Student Center Dedication

The Joe Mack Wilson Student Center was dedicated to the Late Joe Mack Wilson on January 20th. The building was packed with dignitaries as high ranking as Lieutenant Governor Pierre Howard and Representative Roy Barnes.

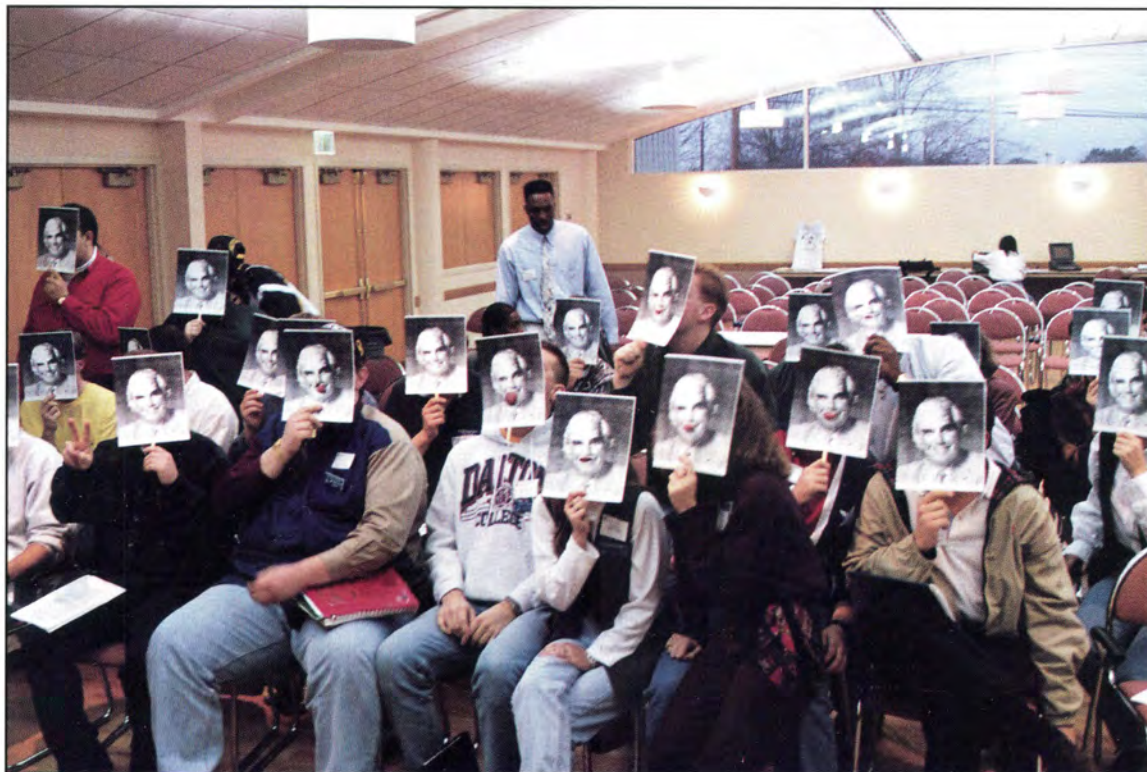

SAC

Southern Tech hosted winter SAC (Student Advisory Council) in February of 1994. The Student Advisory Council advises the Board of Regents on policies and procedures that affect Students.

GOAT NIGHT



Goat Night 1993 was once again the funniest show on campus. It had all the style and grace as previous years. Some of the events included Lip Synch, and the Reverse Beauty Pageant.

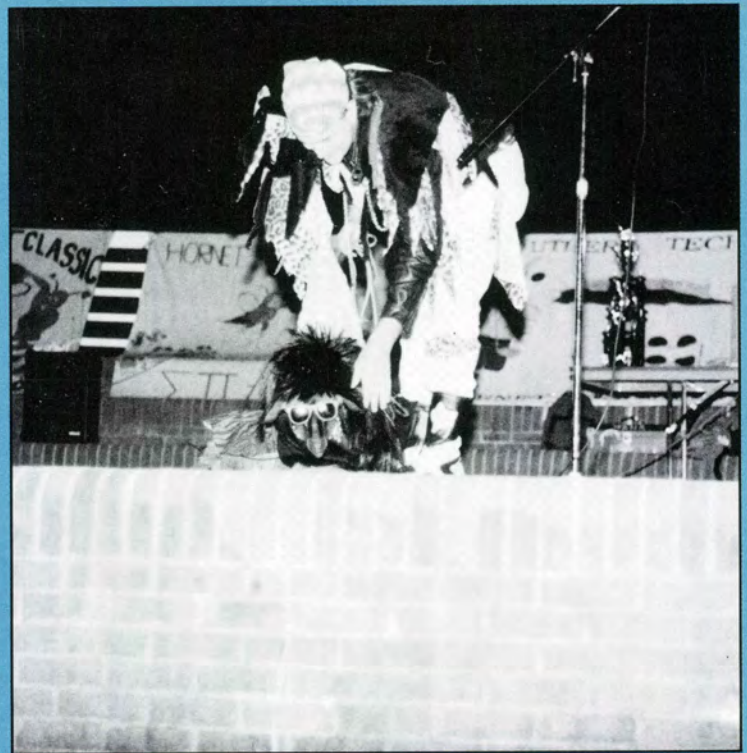

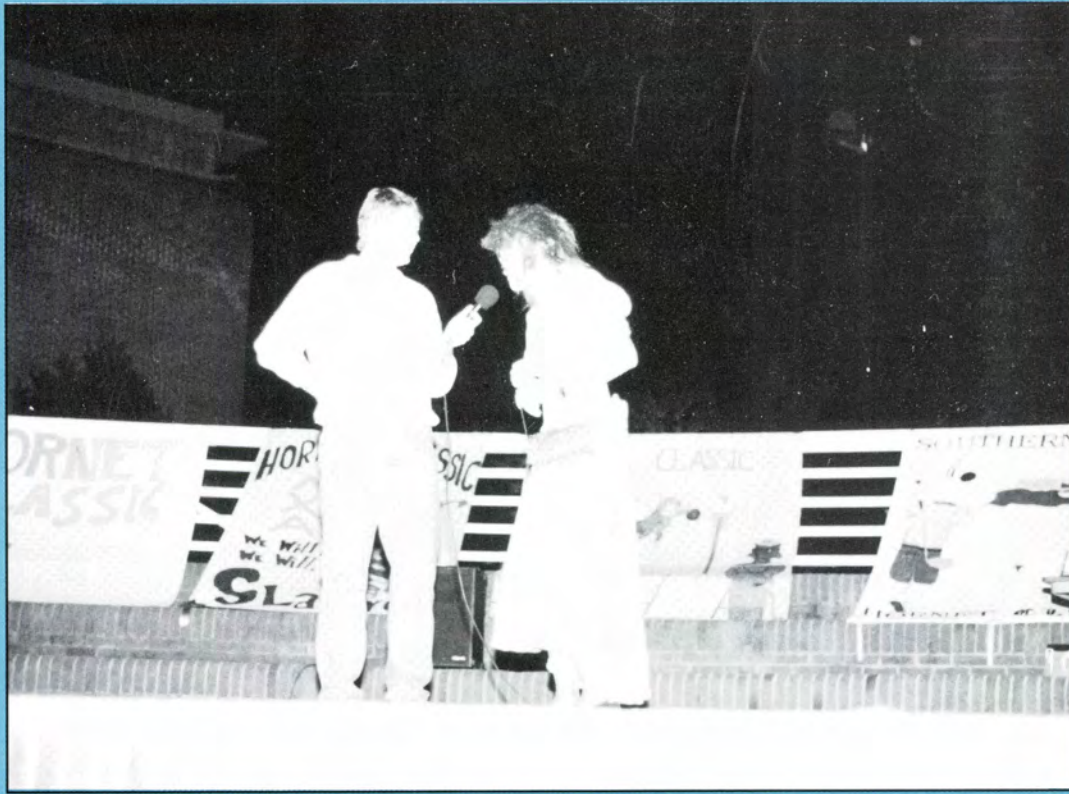

JOE MACK WILSON STUDENT CENTER

On January 20, 1994, the Student Center's dedication was held. The Center was named after the late Mayor of Marietta and state senator, Joe Mack Wilson. Mr. Wilson was a long time supporter of Southern Tech and was instrumental in having Southern Tech moved to the city of Marietta.

Joe Mack Wilson demonstrated through his many years of public service, that a man's greatest rewards come when he has given his all to help those who are not as privileged as others.





STUDYING HARD

When we arrived at Southern Tech, we have had to make a lot of decisions which affected us throughout our college years. We had to decide whether to become involved on campus or not, who our friends were, where we lived, but most important of all was our major field of study.

Once we finished with the core classes and started getting more involved in our major classes, we learned that it was not as smooth as we once thought. But, we kept on going until we reached our goal.

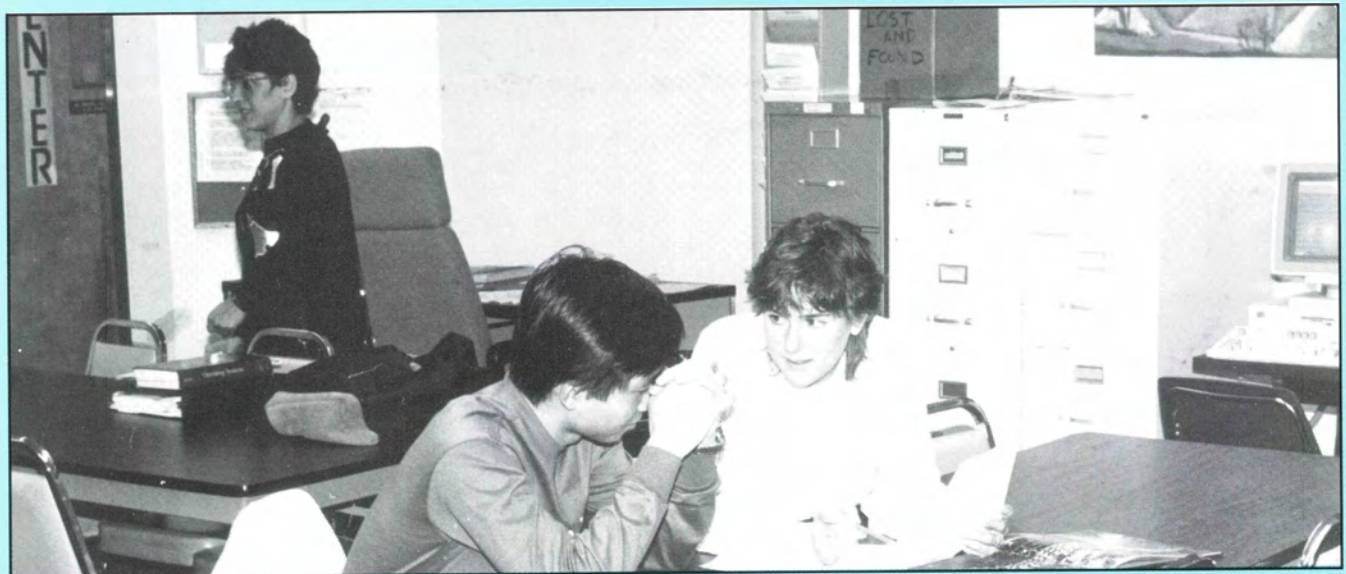
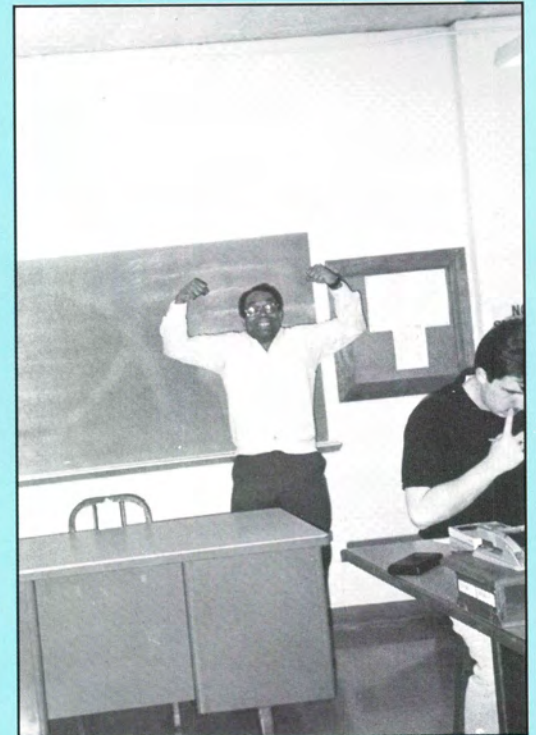
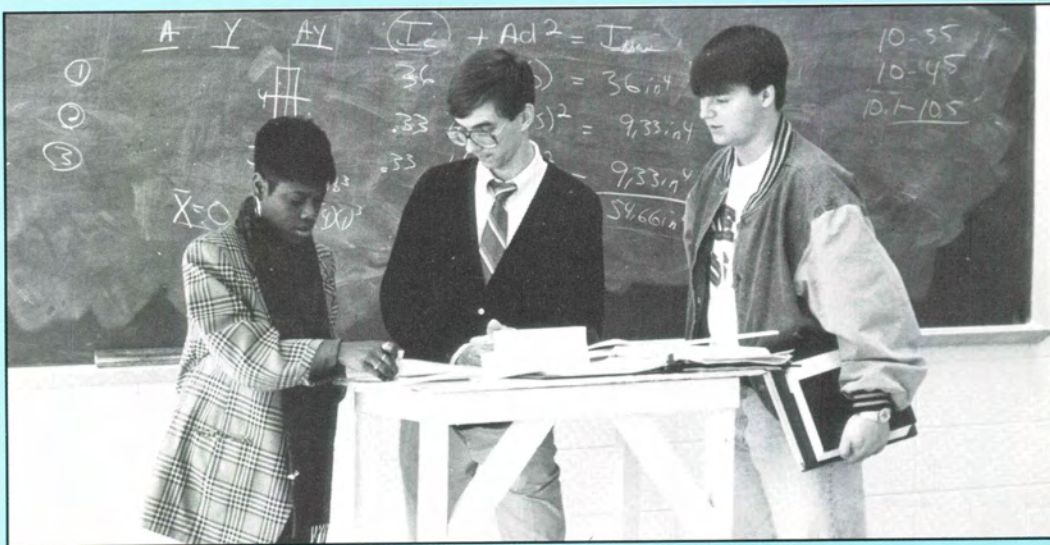

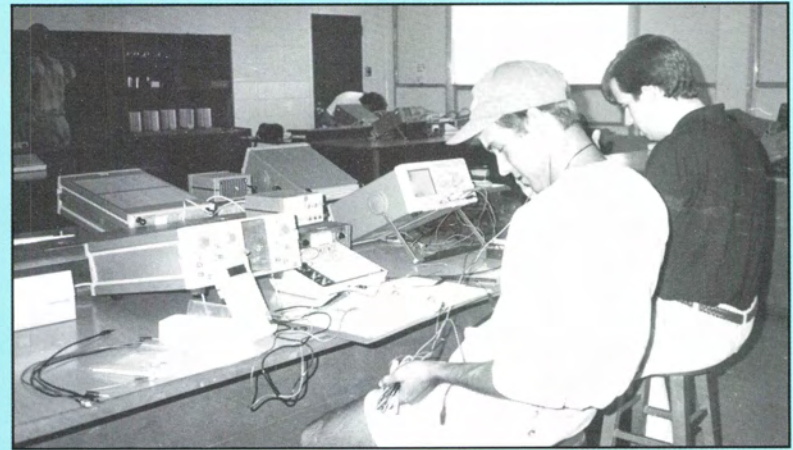

ANOTHER DAY AT SCT

Life at Southern Tech was not always filled with students studying ever minute of the day. Students learned from the very beginning that hard work and no play led to no life at all.

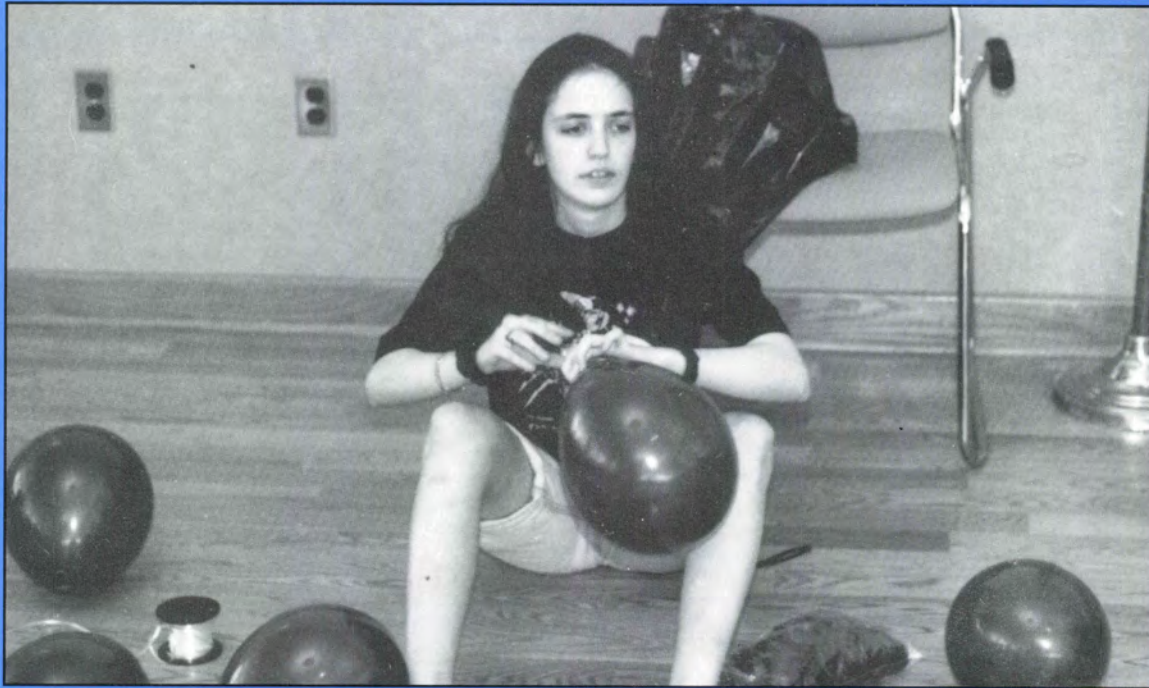



SOUTHERN TECH, A

FRESHMAN'S POINT OF VIEW

Starting college is a tough transition for most students. First, the student must decide what major they will be pursuing. Secondly, they must set up a class schedule. In the "D" Academic Building there is an Arts & Science department, where students can go to get advice on different majors. Also, students are allowed to visit any of the departments at Southern Tech to find out more about various majors/minors. If a freshmen is having a tough time finding something at or around campus, they can ask at the Student Center's Information Booth.

As a freshman this fall '93 I have chosen to become involved in various clubs around campus. A few of these are the Sting, Log, Student Government, and Alpha Delta Pi. Joining clubs/organizations helps freshmen adjust easier to a new surrounding. College students come from many different cities, states, and countries.

Class Schedules, Absence Policies, and Bookstore/Library/Lunchroom hours were among the top concerns of students. Many freshmen have become frustrated with registering for classes when they have to register last and have to take the left over classes. A common question asked on campus "Why are teachers so strict on attendance?" Recent High-school graduates have to get used to not being allowed to miss more than five days in a class. In high-school, a student could miss twenty days and not be penalized. Most freshmen practically died when they found out that the Library closes before midnight. Students, who moved into the dorms, about died when they discovered that the Cafeteria is not opened on weekends. There are many small details students worry about, but at least there are not any severe ones.

Student activities are essential to keeping currently enrolled students from feeling homesick. This college offers an orientation course which assists students when trying to locate different spots on campus. Southern Tech has an advantage of being a small technical college. The student body of this college is relatively close. Fall quarter was the toughest quarter for most freshman, so teachers advisement came in handy for most students. The students on campus are also helpful in finding out different opinions of courses. There were no major problems reported regarding students adjusting to SCT's campus. Overall, Southern Tech is a small, friendly, growing college.

By: Sharon Alese Maddox

“Where is Orientation?”, “Where is Registration?”, “Where is the Business Office?”. These and many other questions could be heard during Orientation from many new Freshmen. Before they could sign up for classes, they had to take English and Mathematic placement tests. After they were given their scores, they had to try to register for the classes they wanted. Some freshmen complained that they couldn’t get the classes they wanted, but I got everything I signed up for on the first try.

When all the freshmen finished signing up for classes, they had to spend a fair amount of time standing in line waiting to pay their tuition. This was the first freshmen class to receive the lottery sponsored Hope Grant. The grant was given to any graduating senior of 1993 with a 3.00 or higher and whose parents earned less than \$50,000. The grant paid for all matriculation fees.

Finally finished with all the paper work and fee payment, the students had to start class. Southern Tech’s campus was not too hard to find your way around, but I got lost in some of the buildings. All freshmen had to take an Orientation class which was helpful in learning about how the rules and processes of college differed than high school. I felt good about the size of my classes because I had heard horror stories of classes with 200 or more students. But all my classes were 30 or smaller, and most of my professors knew me by name and not by number.

After getting into the groove of classes, I decided to explore the extracurricular activities of Southern Tech. I had read the Sting a few times and decided to join the newspaper staff. The people were really nice and explained to me the Who’s Who and the What’s What of Southern Tech. I was told of Tech’s rivalry with the Life Chiropractic College and their leader President Sid Williams. They also told me what professors to take and which ones to stay away from. I enjoyed the extra money and all the free food. I also joined the Log my second quarter and attained the position of Photography Editor of the Sting and the Log by the third quarter. (Although Photo Editor was not bad, I had hoped to achieve Chief Editor of the Sting and Log by my second quarter.)

Although many students lived in the campus dorms or the nearby Student Campus Walk apartments, many students and I had to drive to school everyday from as far away as Douglasville or Fayetteville. Many other freshman had off campus jobs to help pay for their education.

Overall, my freshman year was not as bad as I was told it would be.

By Jarred Fehr

News From

SOUTHERN COLLEGE OF TECHNOLOGY



The Sting

Official Journal of the
Nation's Foremost
Engineering Technology
College

SOUTHERN COLLEGE OF TECHNOLOGY

Cheshier Addresses SGA On Fee Increase

By ED HARDY

President Cheshier attended the July 6, 1993 Student Government Association meeting and accepted responsibility for not warning students that the fee increase to pay for the indoor recreation complex would begin this quarter. He also gave a complete explanation about why the fee increase was necessary now, and not when the building actually opened, as was originally promised.

According to President Cheshier, the original plan was for the Southern Tech Foundation to borrow the money to pay for the

building. They could then use the \$1 million that Southern Tech had already raised by donations from the community to make the yearly payments due on the loan until the facility opened. The student fee increase would go then into effect to make the payments.

Then new Vice Chancellors for both Fiscal Affairs and Facilities were hired by the University System, who urged that Southern Tech instead get approval from the Georgia Legislature to make this a "pay-back" program. This would mean that construction would be guaranteed with bonds sold by Georgia while

securing a lower interest rate to pay for the project. The plan at this time was still to use the previously collected \$1 million to make the \$240 thousand yearly payments to the state until the rec facility opened.

After a tremendous effort, the Legislature did approve the project in late March, during the final days of their session. Unfortunately, once consent was given, it was discovered that the two new Vice Chancellors were mistaken about exactly how a "pay-back" project worked.

With Legislative approval, the project was turned over to the Georgia State Fi-



Southern Tech President, Stephen Cheshier

nancing and Investment Commission, who is responsible for selling the construction bonds. The GSFIC requires that all money to pay

for a project be turned over to them before they will do anything on a project. So the \$1 million had to be turned over to them immediately.

Attempted Dorm Break-In Stopped By RA

By JARRED FEHR

At 3:37 AM on Saturday, January 24, 1994, a person who was not attending Southern Tech tried to enter the Female Floor of the Howell Hall dormitory.

Resident Assistant David Mediate and Resident Director John Stevens were returning to their rooms after supper when while entering the building, a suspicious person entered after them before the door could close.

Mediate questioned the person as to whether he was a resident of the building. The person said that he was a resident and produced a key that

resembled a dorm room key.

Mediate allowed the person to continue, but he followed him to see where he was going. Mediate observed the person walk into a second floor bathroom and overheard him ask another student where the girls floor was. Mediate then asked the man to prove that he was a student.

When the person failed to cooperate, Mediate asked the person to leave the building. Mediate then called campus safety to report a strange person in the dorm.

Between the time Mediate called and campus safety arrived, the person re-entered the building and attacked him.

Both Mediate and the assailant fell down a flight of stairs during the fight. Mediate suffered scrapes on his back, a black eye, and a knee injury where he had been kicked.

Sergeant George Scott arrived after the incident, and told the person in question, Jason C. Reynolds, that if he returned he would be arrested for criminal trespass.

When asked for a comment on the incident, Leigh Boros, a female resident of Norton Hall, said "They should have a check-in counter," but that the doors to the girls' floor should be open from noon to six o'clock due to the number of students who study together.



This is Ed Klein, Director of Housing. We will definitely be flogging our photographers between this issue and the next one. -Photo by Jarred Fehr

Plant Ops Responds To Editorial

By PHIL COLLINS and GREG GIBBS

In an issue of *The Sting*, an editorial by Kassia Cato (staff writer and *Log* editor) was written about the cleanliness of the Student Center and the campus in general.

This editorial prompted responses from members of the faculty, staff, and student body. One vocal respondent was Larry Welch, who supervises the custodial staff.

In a recent interview, Mr. Welch addressed the perception that his staff is lax in their responsibilities. He further stated that these problems will be taken care of in a timely manner.

He feels that his staff has been maligned by the impression that they take "no pride" in their work.

"We want the student to be satisfied, we would also like the student to know there is a difference between being served and being a servant," said Mr. Welch.

A major concern of Mr. Welch is the waste of paper products by students on the Southern Tech campus. However, he admits that our student body does attempt to control waste on a continuing basis.

The replenishment of soap in the restrooms remains a problem that Mr. Welch is addressing. He admits that sometimes the soap is not replaced in a timely manner and that he is working on correcting the problem.

Crime Wave Sweeps Student Center

By KASSIA CATO

On Friday, January 28, 1994, two members of the Campus Activity Board (CAB), were shopping for Casino Night gifts with what they believed was a \$1000 cash advance from the bank. However, it was later found that \$300 was missing.

In an interview with Russ Bagwell, one of the CAB members responsible for buying gifts for Casino Night, Mr. Bagwell stated that he and another member of CAB were to pick up the money at 2:00 PM from the Student Activities office and then go buy the gifts. According to him, once the money was handed over to him in the envelope, he put it in his jacket pocket and never touched the money until it was time to pay for the gifts. It was quite a shock for them to realize that they did not have enough money to pay for the merchandise. Mr. Bagwell then stated that he immediately called Ms. Hewitt and informed her that \$300 was missing.

In an interview on Thursday, February 3, Barry Birkhead, Director of Student Activities, and Vicki Langston, Section Supervi-



This is Russ Bagwell, CAB member, Student Center employee, brother of Tau Kappa Epsilon fraternity, and all around cool guy. He was one of the students who discovered the first batch of missing money. -Photo by Jen Waller

sor, described what happened on the 28th of January. According to them, former Program Advisor, Kelly Hewitt, went to the bank to pick up the \$1000. After counting it again to make sure it was all there, Ms. Hewitt then brought the money to Mr. Birkhead and Ms. Langston who then placed it in the safe in the Student Activities office. Then the money was taken out of the safe and transferred to Ms. Langston's desk, where it was locked. The money was to be picked

up by the two CAB members at 12:00 PM, before the office staff left for lunch. However, the two CAB members did not show up. Making sure the money was safely locked in Ms. Langston's desk, they went out to lunch. Upon returning to the office, Mr. Birkhead and Ms. Hewitt took the money out of the locked desk. Mr. Birkhead stated that when he fanned out the money to look at it, that it did not look like \$1000, however, he thought that maybe some of the bills were stuck

together. Thinking that nothing was amiss, Mr. Birkhead and Ms. Hewitt have the money to the two CAB members.

This was not the only money that was taken from the Student Center. On Monday, January 31, 1994, \$122 was taken out of Ms. Langston's locked desk. The money was the Thursday and Friday receipts from the recreation room. Forty dollars of Rec Room money was taken from the student center information desk that week, also.

Students Sponsor Teacher Evaluations

By KASSIA CATO

The Sting and the Student Government Association are once again sponsoring teacher evaluations. The purpose of the teacher evaluation is to give all students the opportunity to hear the opinions of other students regarding professors in their field of study.

In a recent interview with SGA President Scott Wages, and Editor-In Chief of *The Sting*, Jennifer Waller (who also heads the public relations committee in SGA), Miss Waller stated that the

idea for teacher evaluations came about out of one professor's comment about the need for a student-funded teacher evaluation. After getting support for this idea from SGA, Jennifer Waller and then-SGA-Vice-President Scott Wages worked diligently at getting the first teacher evaluation printed. The evaluations are based on a model that Emory University has printed up for students.

SGA council member, Beth Meeker, expressed concerns that many of the faculty

in her Total Quality Management (TQM) class had over the fairness of student-funded teacher evaluations. The major concern of the faculty, according to Ms. Meeker, had to do with students' giving professors a bad rating just because they did not do well in the course.

SGA President Scott Wages' answer to council member Meeker was to say that the faculty concerns would be taken into consideration and that a new version of the form would be printed; however, that these evalua-

tions are made by students and only for student use.

When interviewed at a later date, Mr. Wages and Miss Waller were asked to go into greater detail about the concerns of the faculty against students giving bad evaluations.

Mr. Wages again stated that the evaluations were not being done to demean or degrade the faculty in any way. He then went on to say that if the faculty felt threatened in any way, maybe they have something to worry about. However, professors who are doing a good job do not have anything to worry about.

EDITORIALS

FROM THE STING

Are Life Students Crooks or Deadbeats?

By **BILL GREVE**

Not all Life College students are deadbeats or crooks, but enough are to get national recognition and their names in the paper (Mark A. Paterson, Marietta, \$90,129.14). First the cold hard facts before the unevenhanded moralizing (James E. Walker, Marietta, \$139,141.52).

The U.S. Department of Health and Human Services (HHS) recently published the names of 5,000 health professionals who defaulted on their Health Education Assistance Loan (HEAL). In the Sunday, September 5, 1993 issue of the *Atlanta Journal/Constitution*, the names of Georgia students who defaulted were pub-

lished. Not surprisingly, two-thirds had attended Life (Victor T. Palffy, Marietta, \$126,318.41). Nationally, chiropractors accounted for 37 percent of HEAL defaulters, with LIFE COLLEGE IN MARIETTA greedily gobbling up TEN PERCENT of HEAL debt across this great country of ours (Lee R. Bain, Marietta, \$103,232.98).

A total of 178 Georgia students attending Life College have racked up \$9,830,478.23 in bad HEAL loans. That puts them up there with Brazil and Iraq, and Life wasn't required to release any hostages. Who was in charge of financial aid, Christopher Drogoul?

That's what is wrong with this country, borrow-

ing money from the government and being expected to pay it back (Kenneth L. Hundley, Dallas, \$127,845.41). Seriously, we forgive loans to other nations, we've let countries nationalize private U.S. companies, and we've looked the other way when human rights abuses might interfere with a profit. The least we can do is forgive a few hapless souls who wished to pursue a pseudo-degree in back rubs (John Duker, Smyrna, \$104,406.08).

And what to make of Wayne W. Rice of Marietta defaulting on \$610.52? Should we assume he took out a large loan and has made a conscientious effort to pay it back, or should we laugh at

his diminutive effort while his classmates were walking off with the treasury (Roseann Spears, Marietta, \$98,023.56)?

Despite Sid's stylish commercials, I expect if he has been around 100 years ago (and who's to say he wasn't?) he would have been selling band instruments in River City.

When I called a chiropractic clinic in Marietta, I was quoted a price of \$25 for a maintenance adjustment: physically adjusting the spine. This procedure would take about 15-20 minutes. Then, calling a massage parlor (also in Marietta), I was quoted a price of \$60 for a one hour Body Shampoo - \$45/half hour. Price wise, the two are

comparable, and the Body Shampoo includes a sauna, being scrubbed down in the shower, and a rubdown afterwards! You make the call.

Yes, I know, it's expensive to attend Life College; tuition runs about \$2700 a quarter plus lab fees and books (Allen R. Lafleur, Marietta, \$107,969.76). So what. You knew that, how about taking a little personal responsibility here. Dr. Moeckel (Timothy S. Moeckel, Atlanta, \$51,243.79) is quoted in the *Journal/Constitution* as feeling misled by Sid. Like the song says "Who is more fool, the fool or the fool who follows the fool."

BILL GREVE is a loyal Twins fan and the new Assistant Editor of The Sting.

We Already Gave You Money

By **JEN WALLER**

Every quarter, students taking over six hours pay their student activities fee, a thirty dollar fee that is stated in the Student Handbook as being used "...in direct support of the various student activity programs of the college including the operation of the student center, the recreational sports program, the campus radio station, the student newspaper, the student yearbook, and various activities of the Campus Activities Board including dances, movies, concerts and other entertainment programs." The purpose of the student activities fee is clearly spelled out. The money is to go toward student activity programs. Some proposals have been made, however, to use the

money to support other services on campus.

A request has been brought to the attention of the Student Government that some of the money that students pay to fund the many different student activities be used to extend the library and computer hours that fall far short of what students need and deserve. At first thought, this idea seems like what could possibly be a good solution to an existing problem. But on the other hand, when you actually takes a few minutes to consider exactly what this type of suggestion could do the school, you can plainly see the problems that will be caused if this idea is implemented.

I know that most students agree that the current hours of the library are not

sufficient to accommodate students (see Bill's editorial). This problem was magnified a few quarters ago when the library hours were cut. For some reason, the school couldn't seem to find enough money in its \$20.4 million budget to keep the library open during the hours that the students desire. Now, what makes anyone think that the students should have to pay for these extra hours from the relatively puny \$300,000 that we pay for leadership skills training, entertainment, and plenty of resume fodder?

Some council members raised quite a strong objection in the last Student Government meeting when the idea of our (meaning "student's") money funding outside departments was raised, since this is not the

purpose of the student activities fee. This will obviously be setting a bad precedence for the use of the fee, since using the money for the wrong purpose will create an all-new wave of "Hey! If the students want [fill in your favorite service here] let them pay for it!" Robbing student-funded, student-run organizations of their money is not the answer to this problem.

We don't need to start the habit of tucking our tails between our legs and reaching for the Student Activities wallet anytime we are deprived of what we, the customers of Southern Tech, deserve. The outside departments will not be "ashamed of themselves" or "embarrassed" at the idea of students paying for the extra hours. Like anyone else, they

would be overjoyed by the thought of getting extra money after not putting what they were originally granted to its best use.

Since hindsight is almost always 20/20, when the library hours were originally cut, the Student Government members should have sent a loud, demanding, "OH NO YOU AREN'T!" to the offending parties. But it's too late for that now. We have to demand that the hours be extended. We must not pay for additional hours for other departments with Student Activities fees, since that would be making the mistake of being too passive again.

JENNIFER WALLER needs to think of a pithy comment to go here, so she put this unpithy one in to make it easy to place.

THE WORLD RIGHT NOW

There are many things affecting our world right now in 1994. There is a war in Bosnia, Famine in Somalia, New legislation designed to make Health Care affordable to all Americans made for big news in 1994. How this will affect the future only time will tell.

The Georgia Flag

No issue has swayed the general populous of Georgia than Governor Zell Miller's attempt to change the Georgia Flag back to the flag that flew prior to 1956. Governor Miller was defeated on the flag issue by the General Assembly but the battle was not yet over. During the 1994 Super Bowl, protesters descended on the Georgia Dome and let the world know how they felt about the flag.



Bosnia

The ages old struggle between the Muslims and Christians in Bosnia flared up in what was once Yugoslavia. As the Iron Curtain fell tempers flared and the conflict renewed. The once proud city of Sarejevo was destroyed and besieged for months. Finally after a shelling that the city of Sarejevo took that killed only civilians, President Bill Clinton along with other leaders of NATO countries, issued an ultimatum that pushed the Bosnian-Serbs back from the city.



1994 Winter Olympics

The 1994 Winter Olympics took place in Lillehammer, Norway. The Winter Games took place for the first time in their new off year configuration. Dan Jansen finally earned the gold medal that for so long had eluded him. Bonnie Blair became the most decorated American female Olympian with her fifth gold medal. Americans were also a presence in Alpine Skiing thanks to Tommy Moe and Picabo Street. But the most watched Olympians of them all were from the sport of womens figure skating. Nancy Kerrigan ended up being the silver medalist after all the controversy surrounding an attack in which her teammate Tonya Harding was allegedly involved.

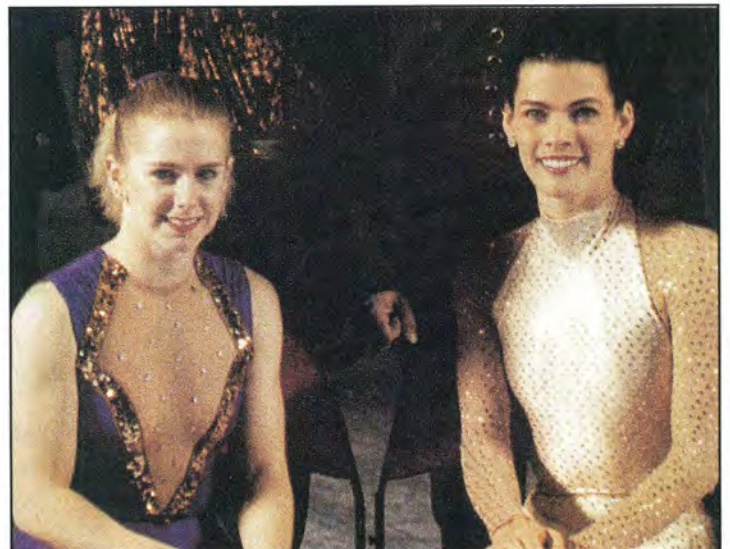



Super Bowl XXVIII

Atlanta Played Host to Super Bowl XXVII in January. The Buffalo Bills and the Dallas Cowboys faced off in The Georgia Dome in what was a matchup of Super Bowl XXVII. Once again the Bills lost and Dallas walked away with the championship rings

Middle Eastern Peace

After years of fighting among themselves, The Israeli and Palestinian delegations began to finally come together and find peace in an area that has been warring for decades. Only time will tell how long the fragile peace will last.



The Tokars Case

In what was to date the most celebrated and talked about criminal case in Atlanta History Fred Tokars, accused of having his wife Sara killed in front of their two young sons, was Arrested and placed on trial for drug trafficking and money laundering. Due to the publicity that the trial generated locally, The trial was moved to Birmingham Alabama.



SECOND WOMAN APPOINTED TO SUPREME COURT

President Bill Clinton made his first appointment to the U.S. Supreme Court. The nominee was one that both liberals and conservatives in congress could agree on. Ruth Bader Ginsburg became only the second woman after Sandra Day O'Conner to join the Supreme Court.



LORENA BOBBITT

Lorena Bobbitt was charged with the malicious wounding of her husband John after he allegedly raped her. He was acquitted of marital rape. Lorena was found not guilty by reason of insanity and committed to a mental institution for 45 days

HE'S BACK

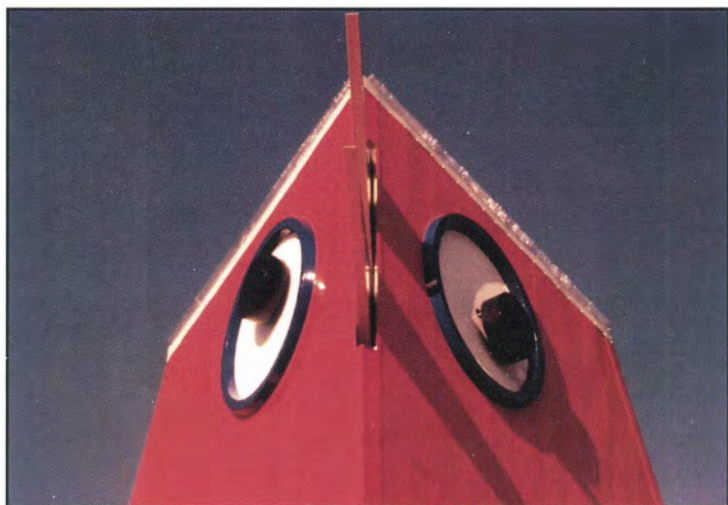

The most famous landmark in the history of the city of Marietta was torn down in 1993 due to structural damage. A contest was held to decide if the design was to be altered but the old chicken ultimately won out.

The Original Chicken was built in 1963 by S.R. Davis for his Johnny Reb's Chick, Chuck and Shake. It was sold to Kentucky Fried Chicken and has served as landmark for 30 years.



POEMS BY

BRYAN TIDD



OF LOVE

Over Me, Her hair closes in a world
including only us. Her eyes,
brilliant, invite me into her. Her
lips, soft, melt two to one.
We are love, eternal.

Standing Atop A Mountain

Standing atop a mountain,
I look out towards another. I
wonder if I am part of a great
chain of amateur philosophers,
as long as the Appalachian
mountains, all looking from
mountain to mountain for a
sense of inspiration. Amateur
due to a lack of audience
and experience, not ideals.

In Memory Of.....

This year Southern Tech mourns the loss of three special people Barry Buchannon, Sara Davidson (not pictured), and Claudette Ficik.

Barry Buchannon died in a tragic automobile accident, during winter break. He was fondly remembered by all Southern Tech students as the "Hat Guy" because of all the colorful jester hats he always wore.

Sara Davidson, was a secretary in the Civil Engineering Technology Department. Ms. Davidson was an inspiration in not only courage but strength of character. This was shown in her four-year battle with cancer. Those who were close to her on campus remarked on how she always kept a smile on her face, even though she was in great pain.

Claudette Ficik's disappearance while on her way home to visit her parents in Trenton, South Carolina, shocked the campus as a whole. The campus could not believe that something this evil could happen to a Southern Tech student. The campus banded together to help the police find Ms. Ficik and return her to the safety of her family. We were all sad to learn that her body had been found in the Oconee River.

The staff of Technician's Log dedicates this year's book to Barry, Sara, and Claudette in memory of their loving families and the inspiration they gave to people at Southern Tech.



Claudette Ficik



Also Known as the
HAT GUY

Barry Buchannon

TECHFEST '94

On Saturday, May 14, the Southern College of Technology presented TECHFEST-1994. Many departments were involved in this year's program.

TECHFEST also attracted technology from the surrounding area. Many local and national companies brought displays.

TECHFEST gives the Southern Tech campus the opportunity to introduce the surrounding area to the latest trends in sophisticated technology.

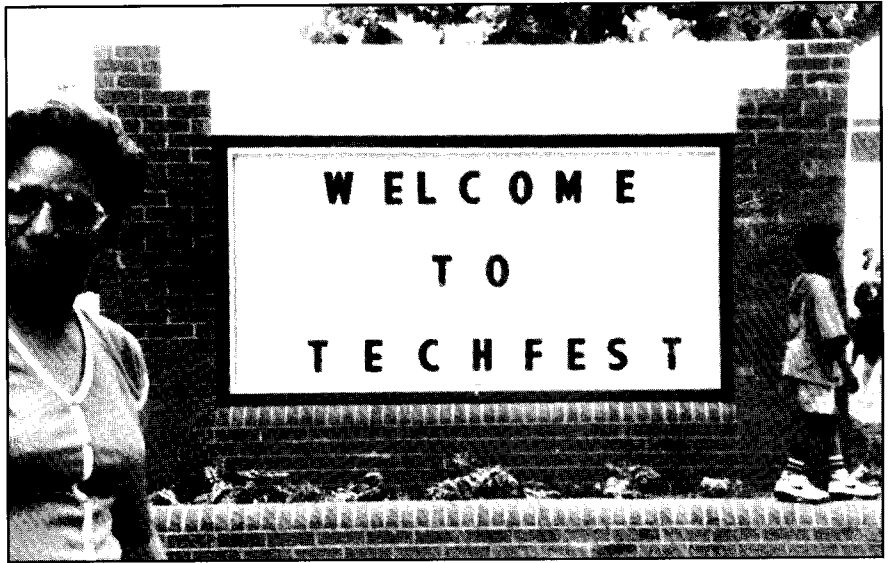

TECHFEST invited everyone in the Marietta community to come see technology at it's best, at no cost. Many Southern Tech visitors enjoyed the hands-on display, where they were given the opportunity to test the systems.



The Federal Aviation flight simulator really impressed the kids.

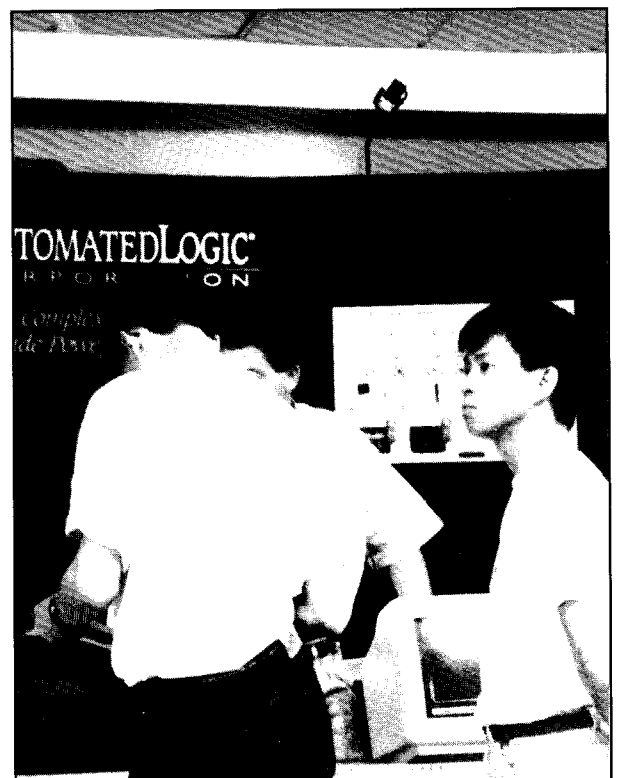

TECHFEST '94



There was always something to laugh about, when Dr. Nuhfer-Halten is around telling jokes.

Some of this year's events included the AH-1 Cobra Helicopter, VSAT Satellite Communications, a space walk, and ROBO (an automated car). In addition, there was a video display of mathematical equations- such as fractals, music transmitted by laser, and the latest trends in tree houses.



TECHFEST was a good way for campus organizations to earn money by selling chicken, hotdogs, and baked goods.

TECHFEST '94



This year's displays also included: a real-time computer-controlled train similar to the system used to run MARTA; programs demonstrating the tools of surveying; computer aided design (CAD) as used in the mechanical and apparel and textile fields.

Other programs featured the RE/MAX hot air balloon giving rides, stump the Spanish professor, and the Jupiter Jump for children. There were also outside performances provided by the Li'l General cloggers, 530th Air Force Band of Dobbins Air Force Base, the McEachern High School drill team, and a barber shop quartet.

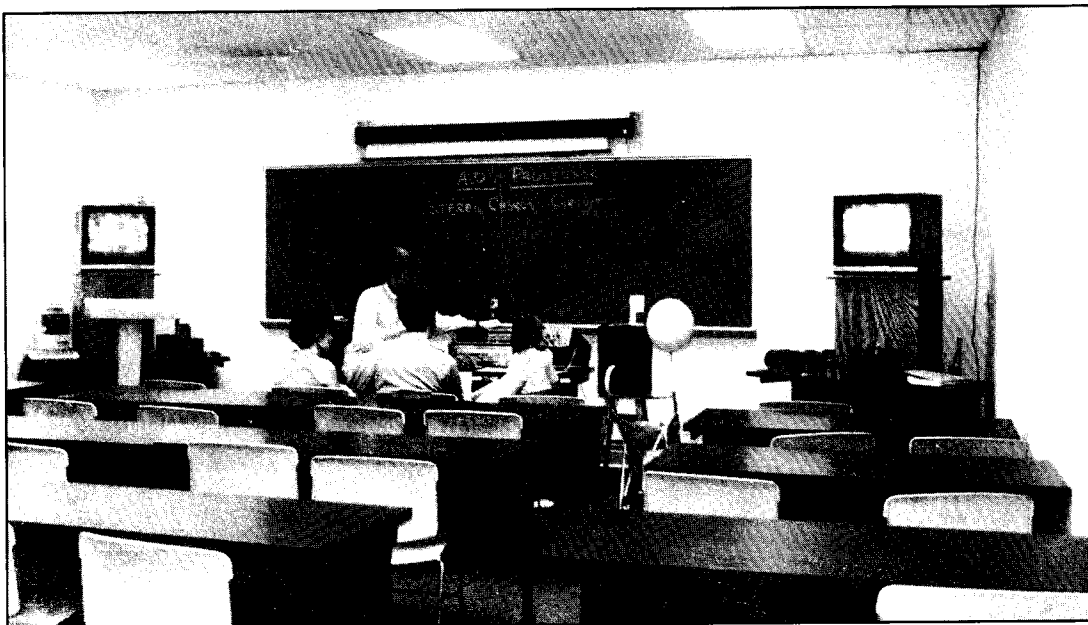
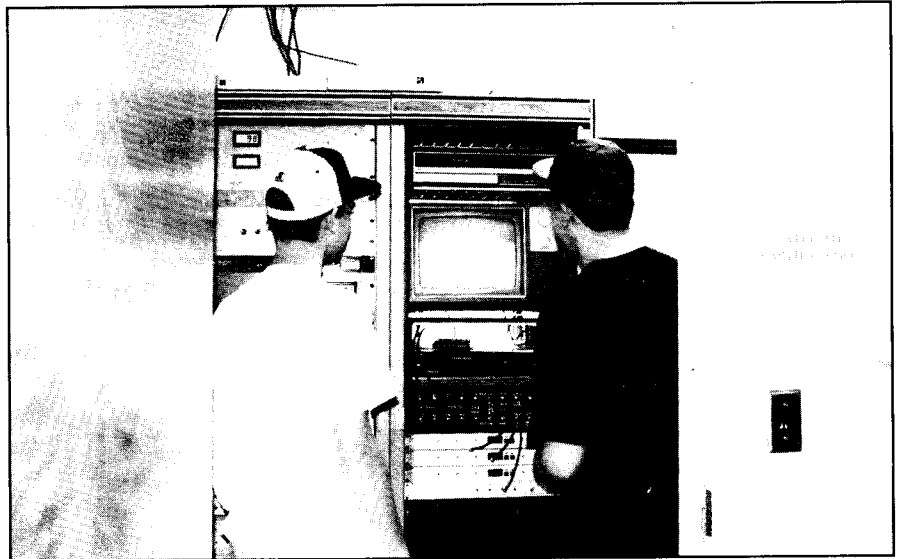

The International Festival was also being hosted the Joe Mack Wilson Student Center Ballroom. Offered along with the International Student Association was a luncheon buffet and international entertainment.

TECHFEST '94

Some other organizations that had displays, and events around TECHFEST were the Federal Aviation Administration (FAA), the Civil Air Patrol (CAP), Naval Air Station of Atlanta, Marietta Fire Department, Marietta City Police, AT&T Tridom, and the Georgia Youth Science and Technology Center.

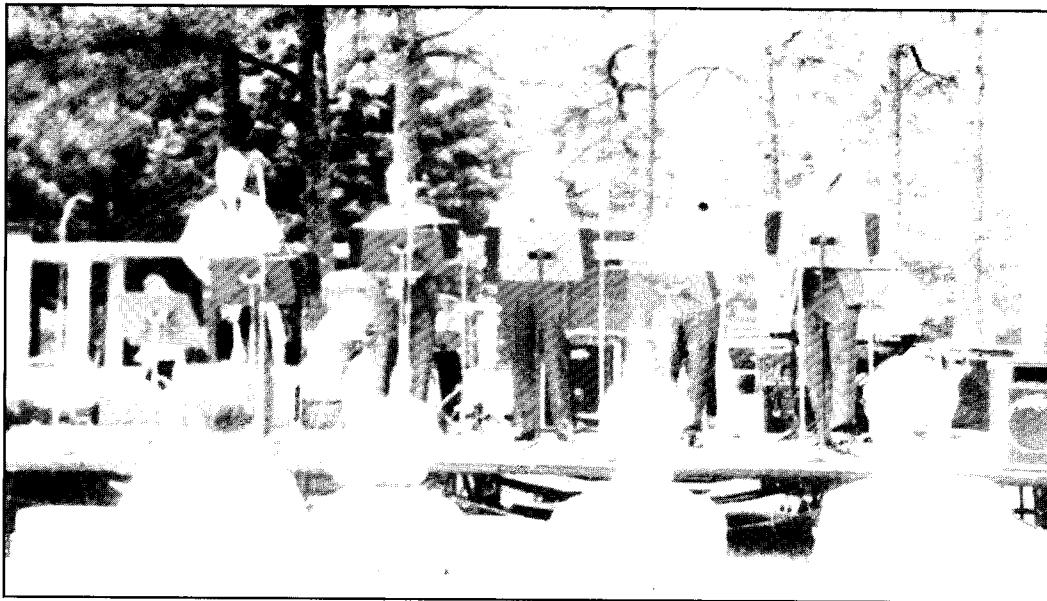

Spring Break 1994

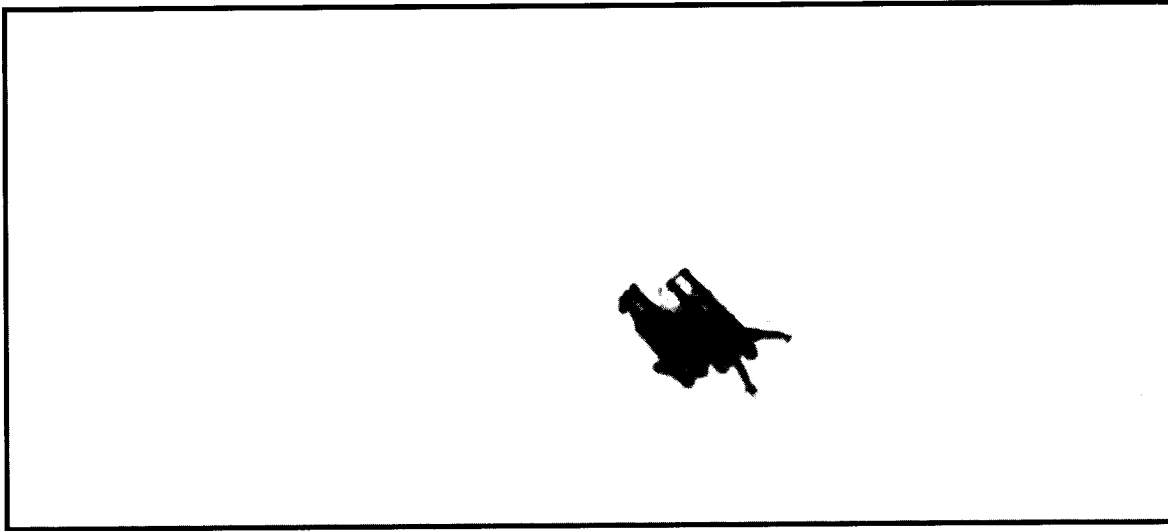

This year's spring break was a lot different from the winter one we experienced last year. Once again college students headed for the warm, sunny beaches of Florida. They were there to release the pressures of final exams and the only way to do that was to party!



Spring Break 1994

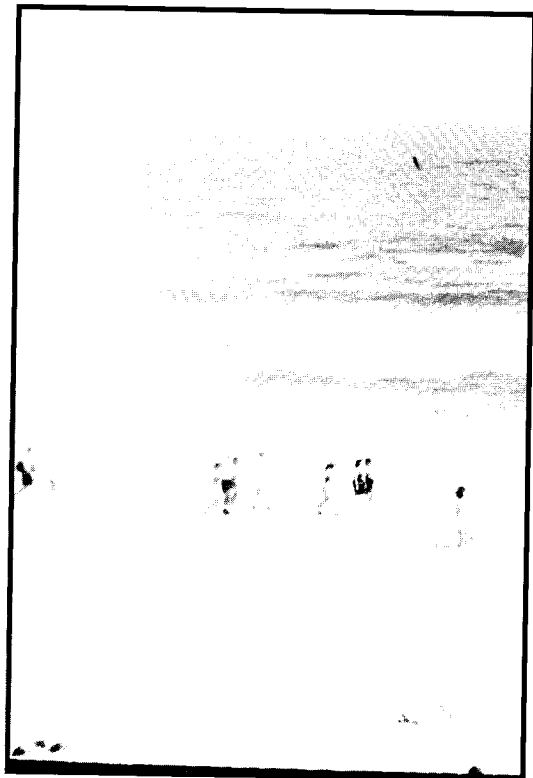

Support Staff

ADMISSIONS



BOOKSTORE



BUSINESS OFFICE



Support Staff

COUNSELING CENTER



FINANCIAL AID



INFORMATION DESK



SUPPORT STAFF

CAMPUS SAFETY





STUDENTS

hardwork
and dedication
is what it
takes

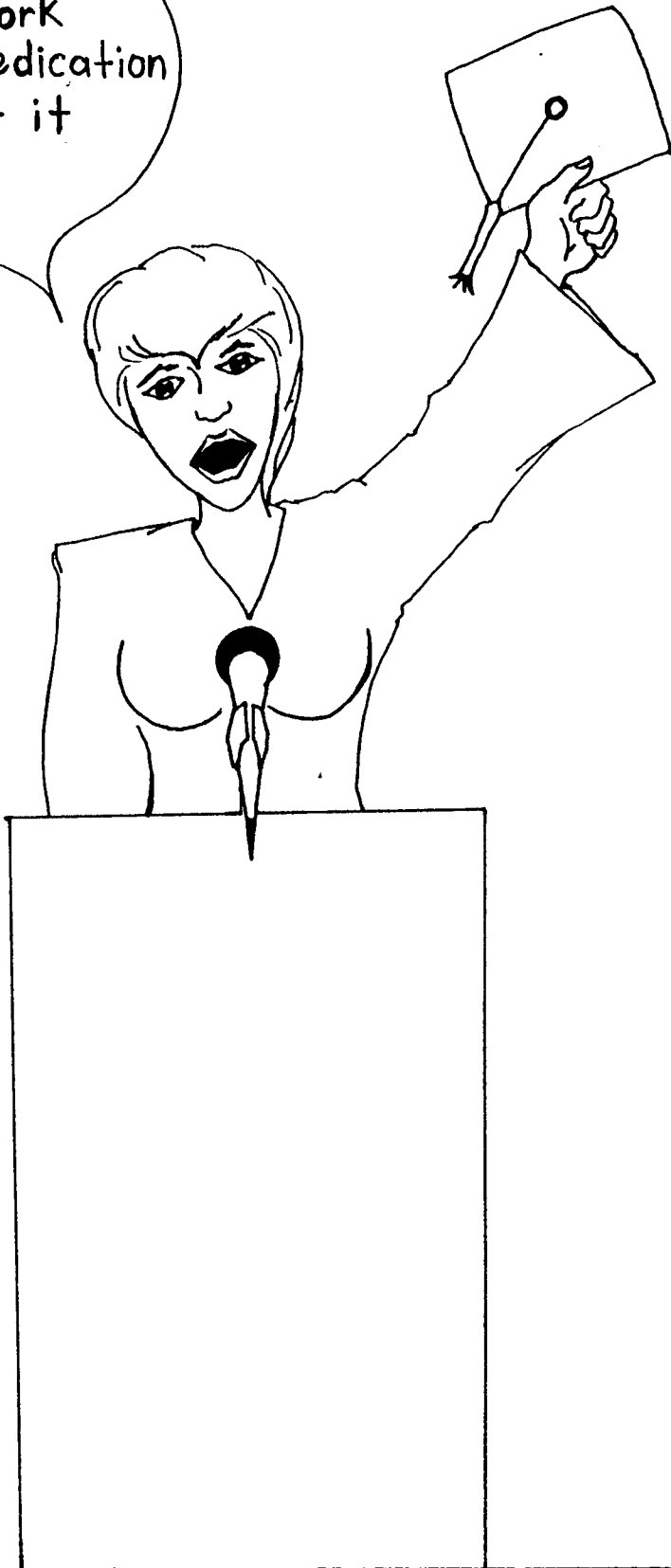

Senior

it's about
time, she has
been in school
10 years

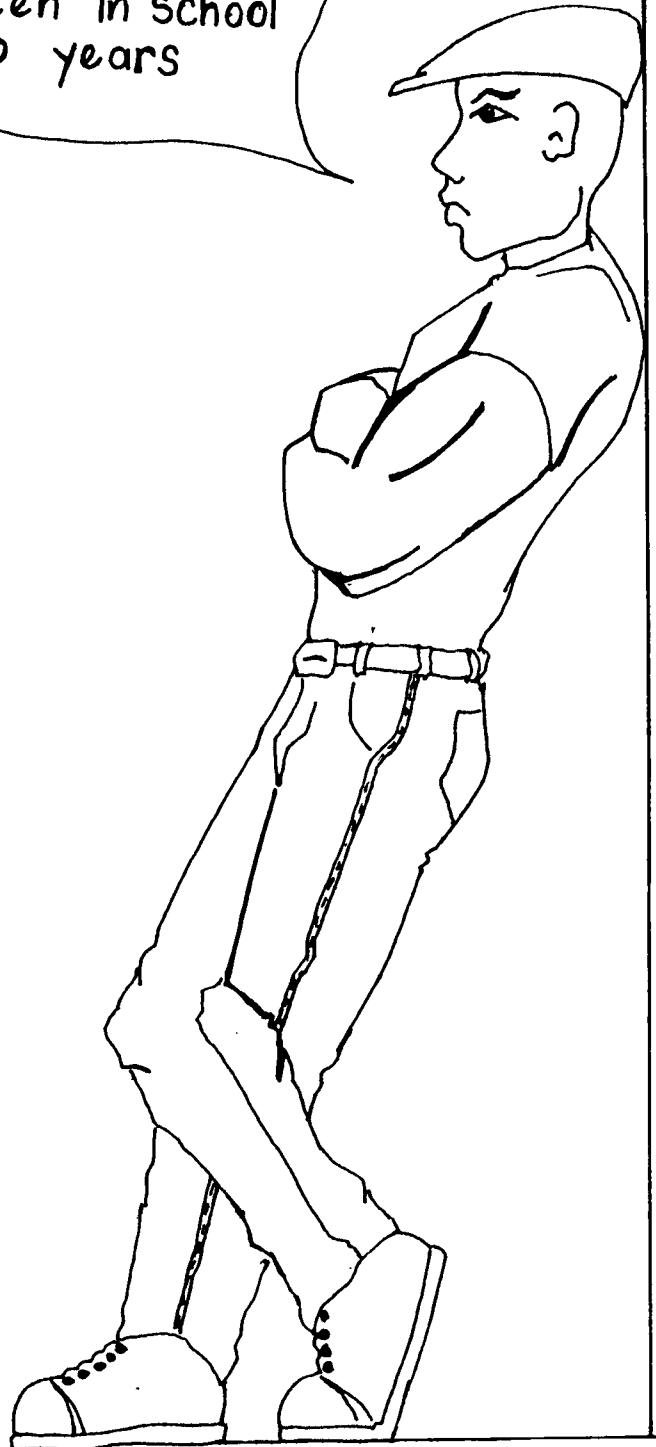

Freshman

STUDENTS

Graduates

Seniors

Underclassmen

(in alphabetical order)

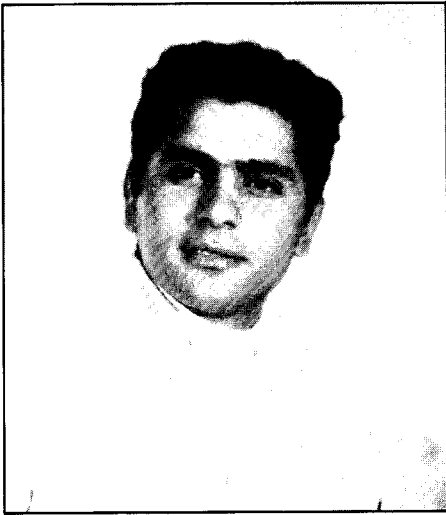

Agushamais, Ehab



Badii, Armin

We all know that the Bachelor Degree is referred to as the BS degree. Our MS graduate students have come back for More of the Same. A sure sign of growth for Southern Tech is the constant work going on to expand the Masters degree programs.

The four programs offered in 1993-94 were Computer Science, Engineering Technology, Technical and Professional Communication, and Technology Management. No one could tell a graduate from the undergraduate, except on Saturdays when some of the grads were in class.

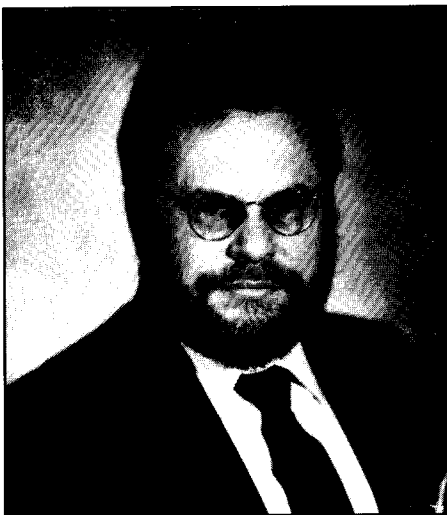

Brown, Robert



Gangasani, Sukanya

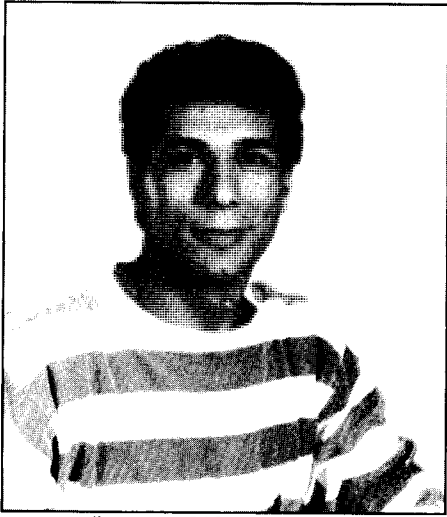

Jassar, Waseem

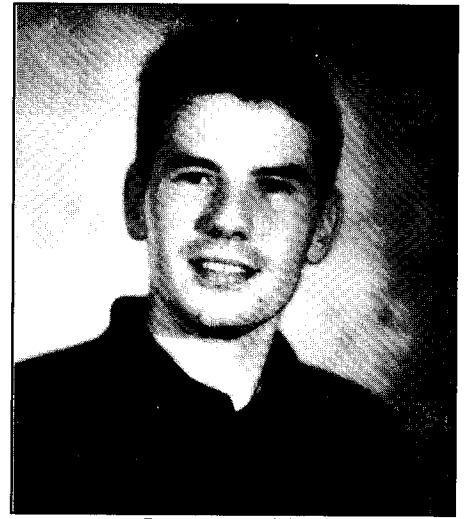

Lawson, Charles



Mann, John

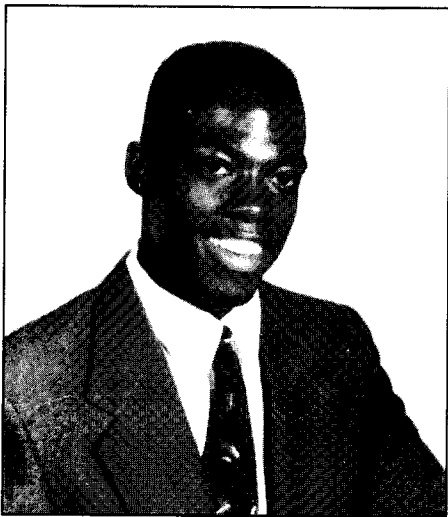

Price, Carl



Wibowo, Johannes

Seniors

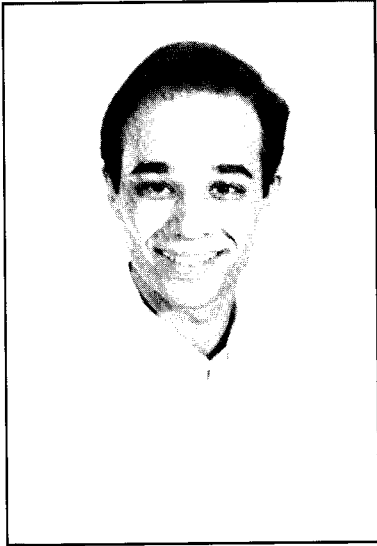

Albritton, Kyle

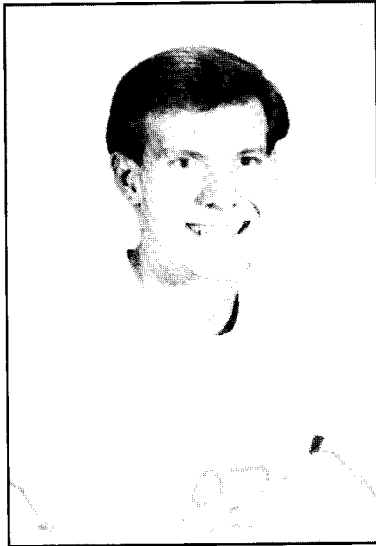

Anderson, Neal



Bailey, Robert

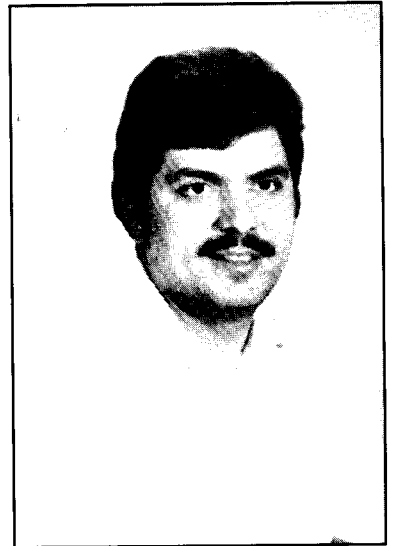

Brown, Douglas



Bryant, Johnny

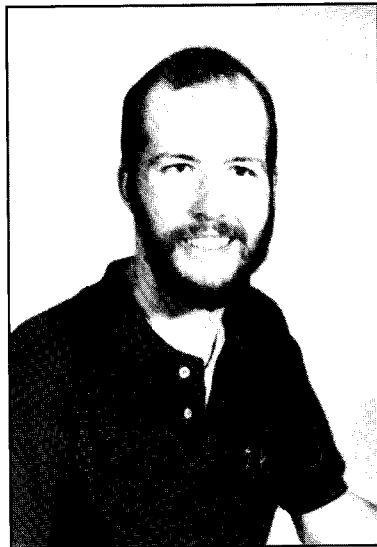

Buhl, Bob



Burton, Stan



Cato, Kassia

In Mrs. Jablanka's fifth grade class tests indicated my only educable qualities were math related. Through years of writing I have constantly been reminded that the standardized testers from Ohio were right. I like to write in my own way; therefore, I could not do it for a living. I also enjoy solving problems when they do not start with Math Word.

When people ask me what am I studying I tell them Civil Engineering. They say, "Oh, so your going to work on bridges or highways, right?"

I try to explain that I'm studying why things break and how to design them so that they will not. I want a career with a firm that consults people with engineering problems and provides them with a solution. Whether it be: airframes or auto; earthen berms or concrete dams; landfills or wetland preserves; or another segment yet to be defined. I hope to one day have Engineer as a title.

My resume will not start: I hope to obtain a semi-challenging position with a moderately paced firm where the simplest forms of engineering technology can provide a level of comfort that would make Marla envious.

Seniors



Coleman, Lee



Cornwell, Kimberly

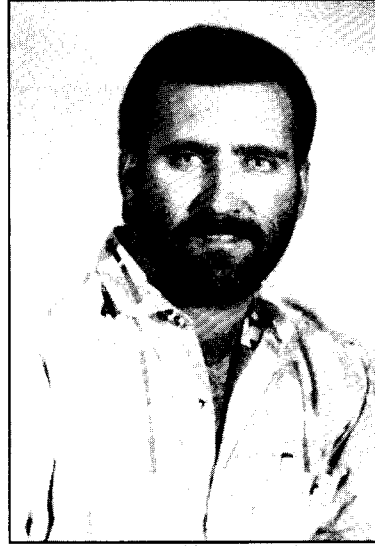

Cutcliff, David



Day, Laree

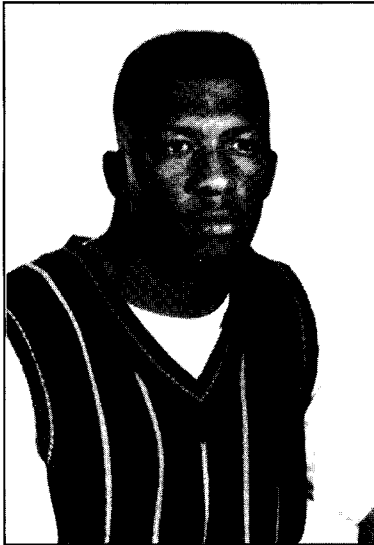

Dunham, Tyron

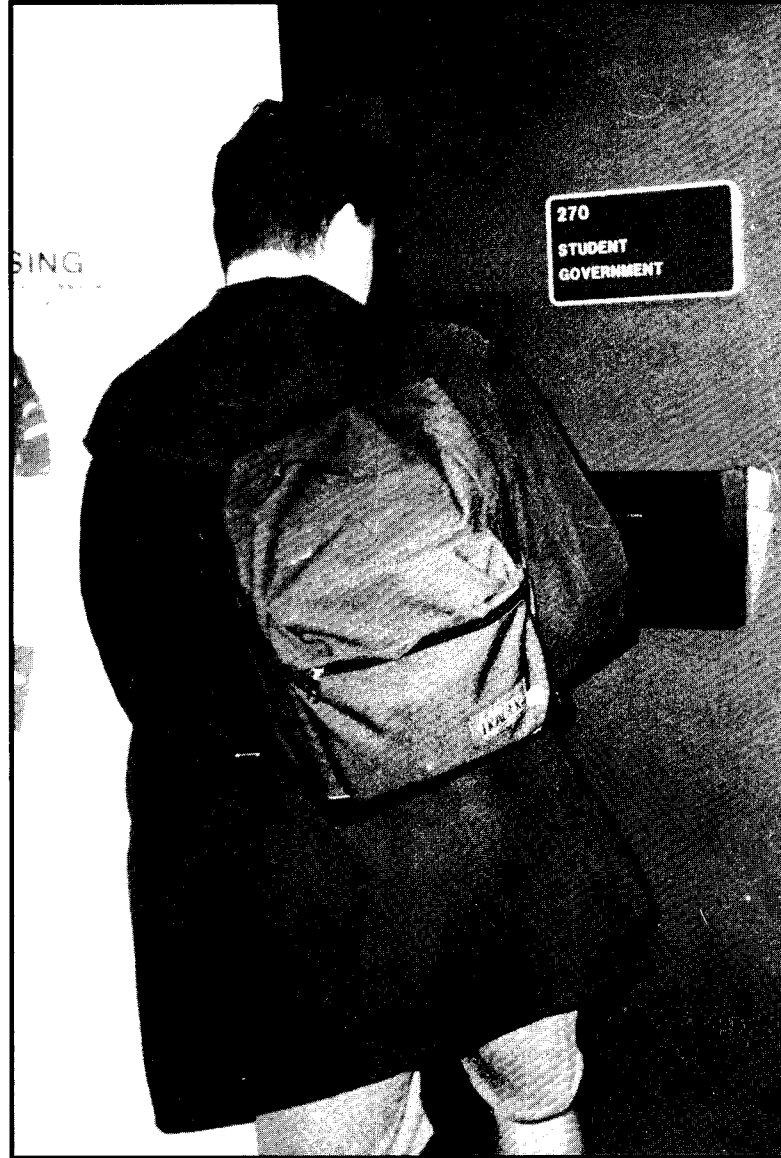

Edwards, Gail



Elliott, Elizabeth



Ellison, Natasha

Seniors



Ferry, Gay

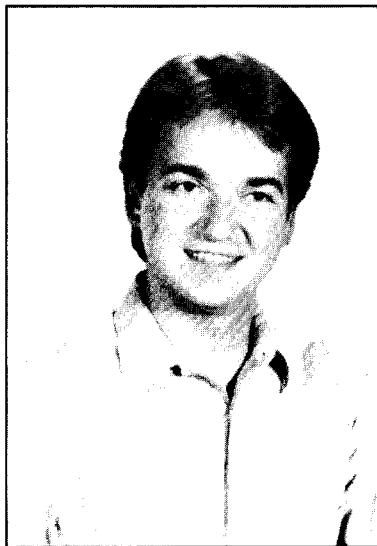

Fisher, Kendall



Grady, Paul



Hadjimirzaei, Kourosh

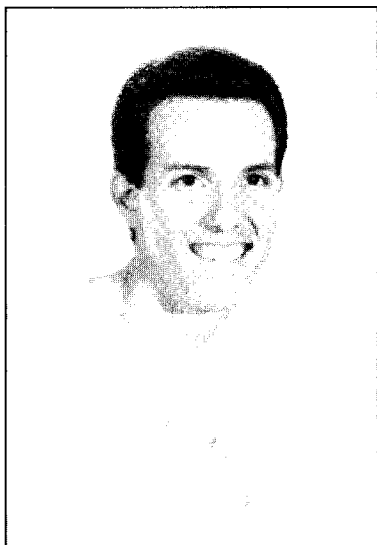

Hardin, Randall



Harper, Wendy

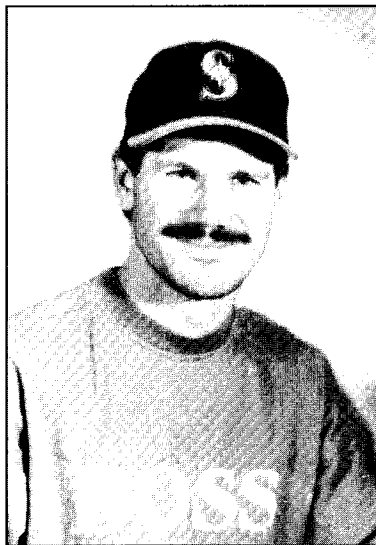

Hayes, Kevin



Hinson, Martin

Seniors

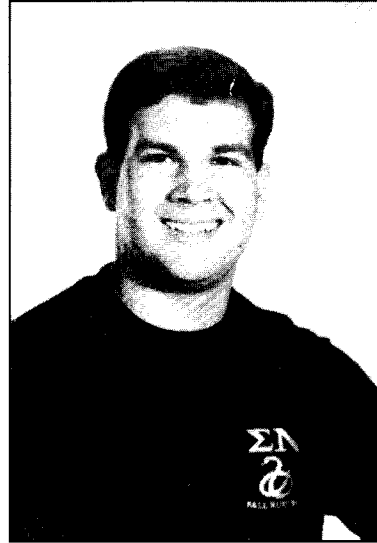

Hutchison, Hutch

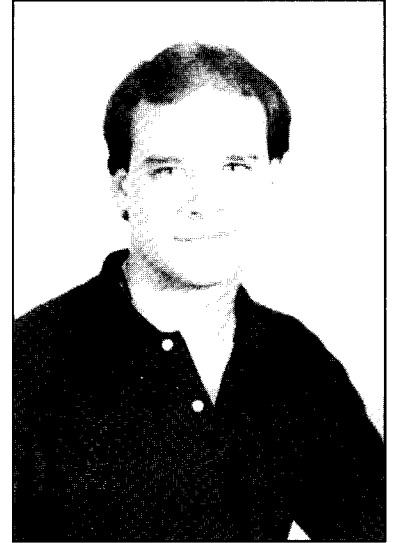

Jones, John



Jorio, Yassir

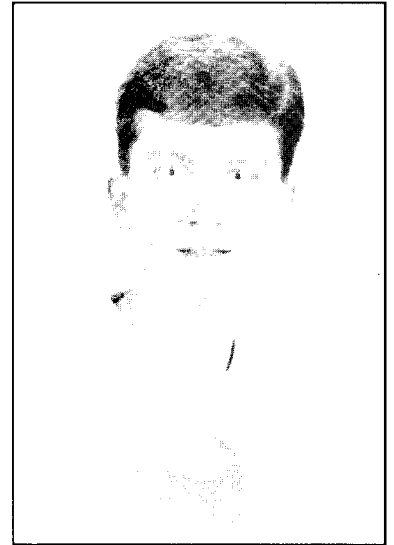

Kiser, Daryl



Koptis, Jennifer

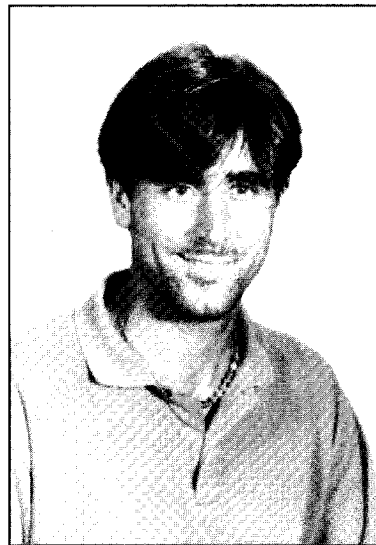

Liangill, Kevin

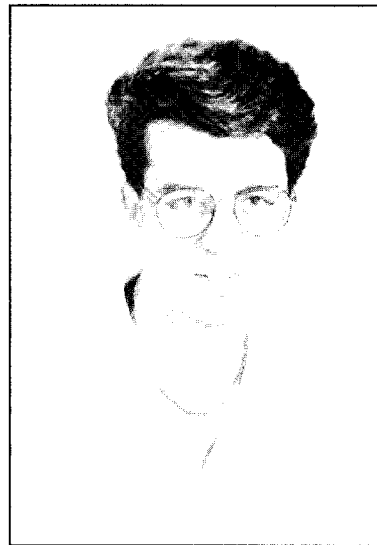

Lindsey, Tyler

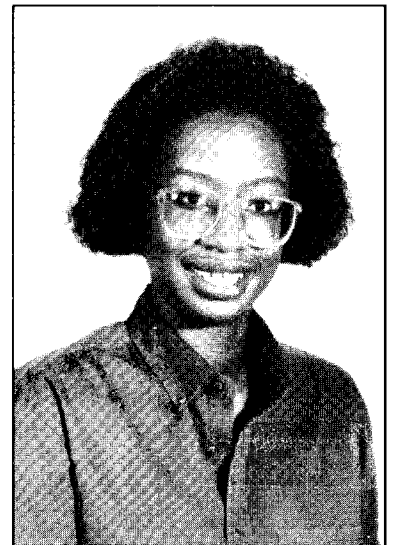

Little, Kimberly

Seniors

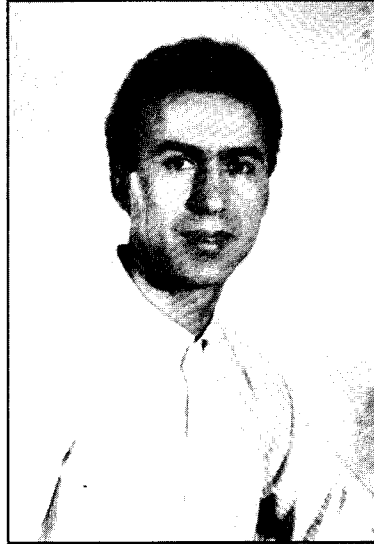

Madjid, Ait-yahia

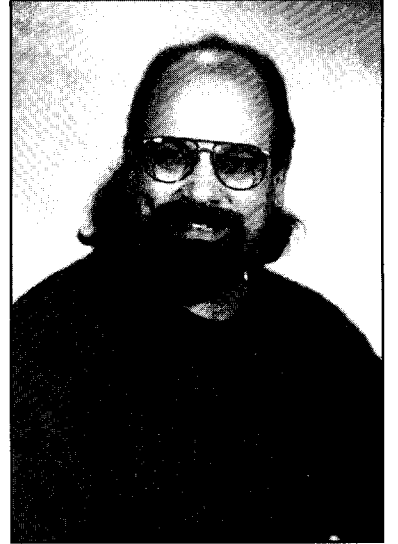

Maurone, Charles

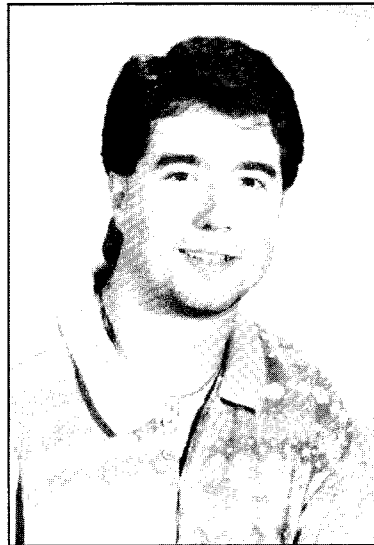

May, Alex

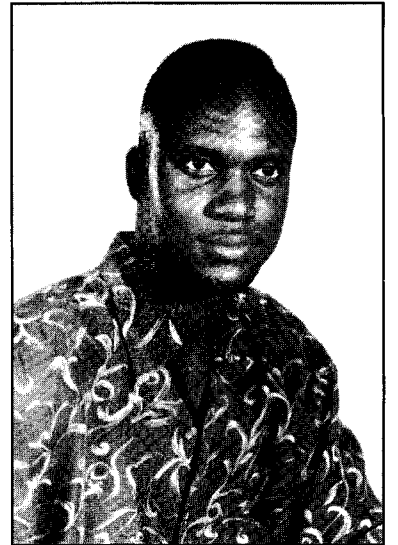

McWhorter, Edward

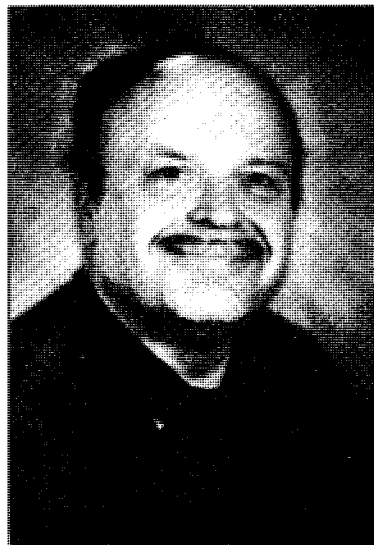

Mederis, Alfred

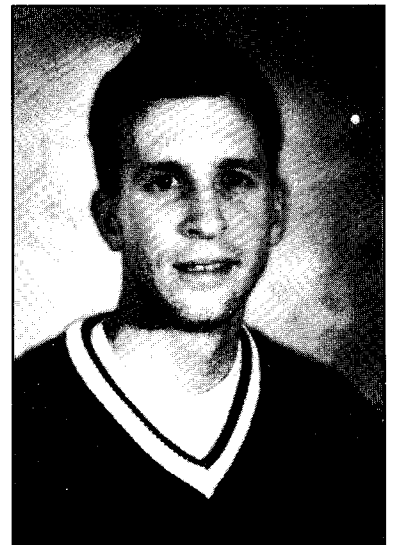

Melillo, Mike

Seniors



Middleton, Angela



Mize, Karen



Morse, Rich



Nagarkar, Vinnie



Nelson, David

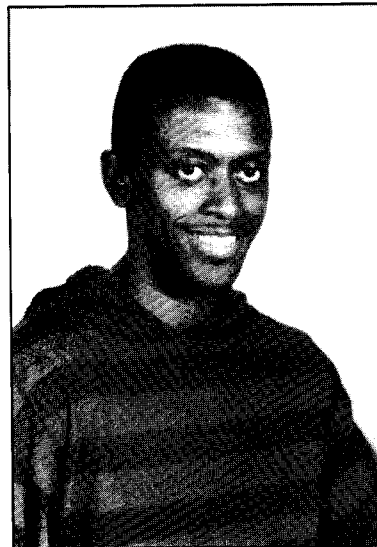

Nichols, Brandon

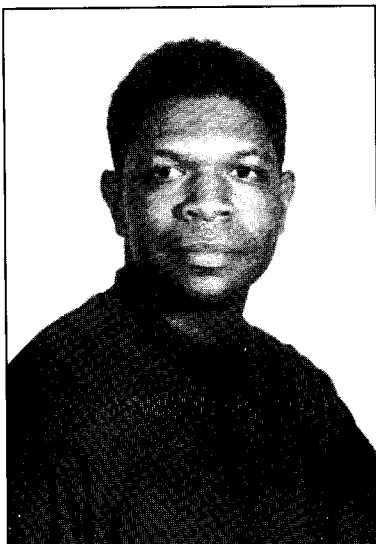
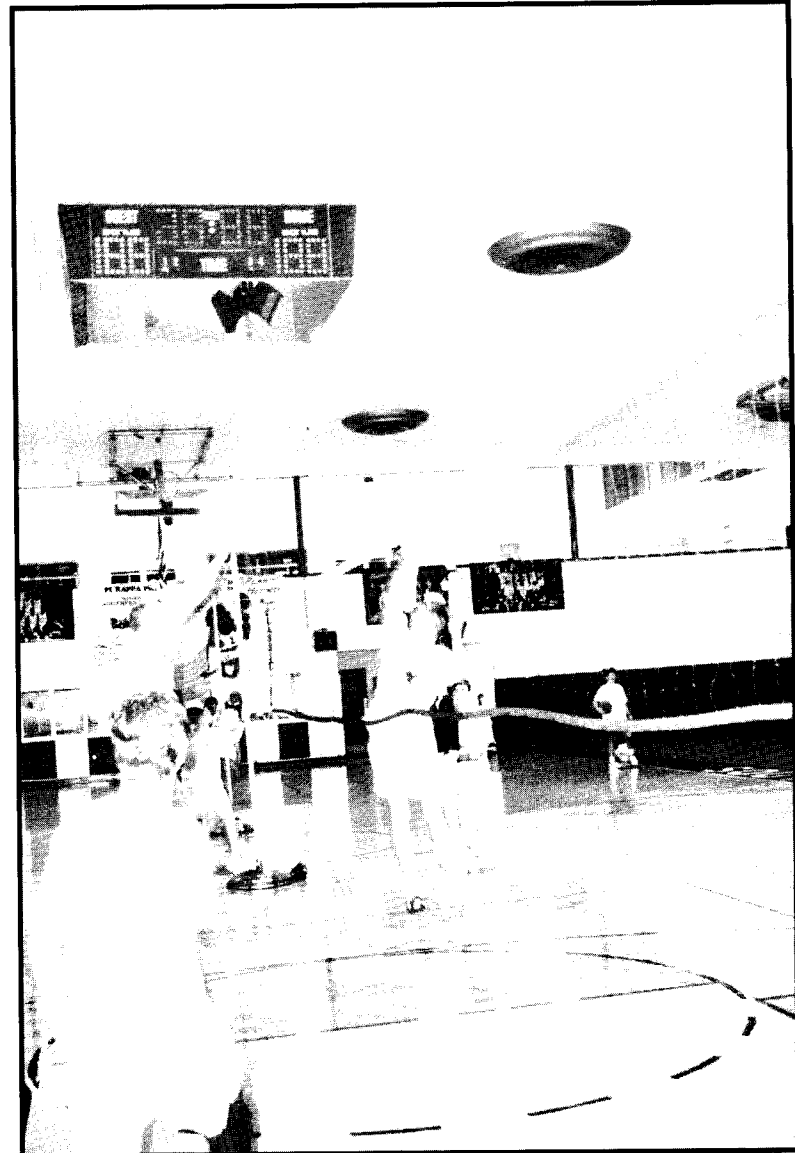

Oliver, Tracy



O'Brien, Jim

Seniors

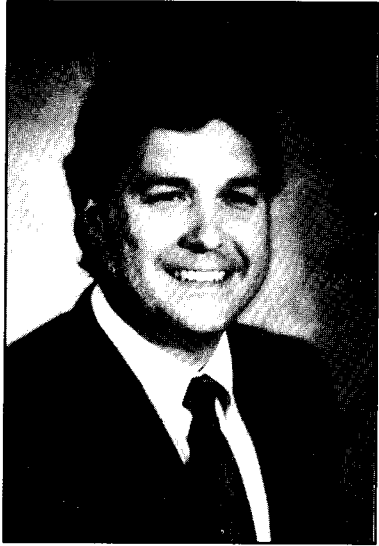

Pearce, Eric

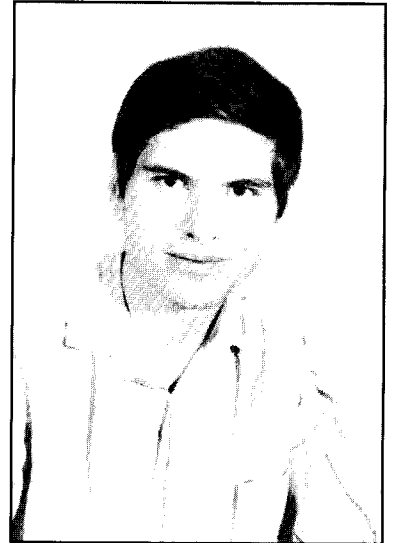
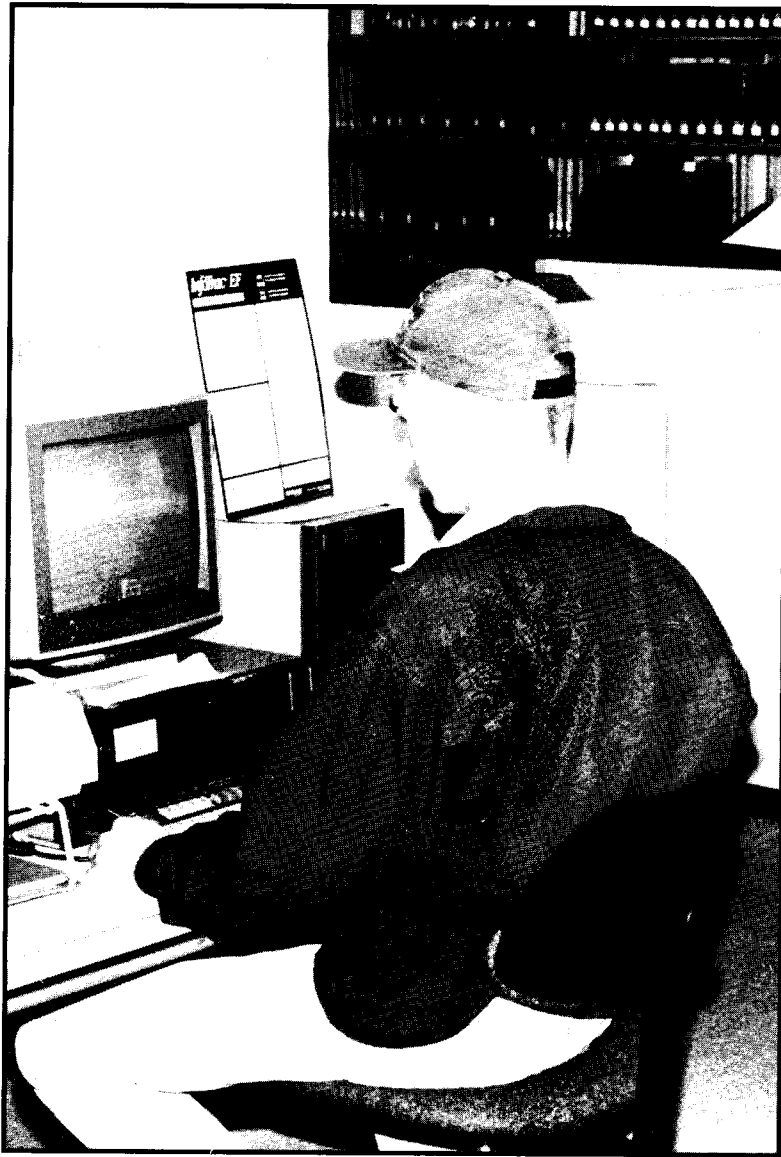

Perez, Tony



Phillips, Patrick

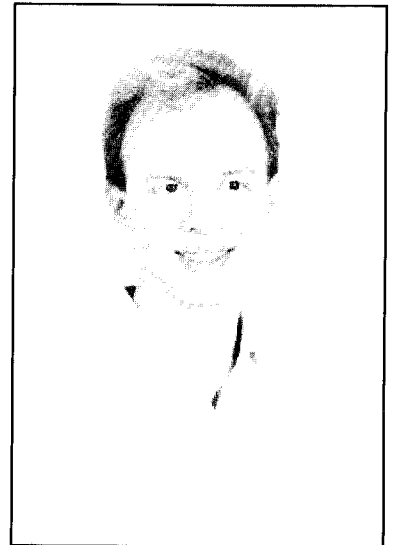

Pickle, Chris



Pollard, Doug



Porter, Shanna



Riggs, Arrow



Rivera, Jimmy

Seniors

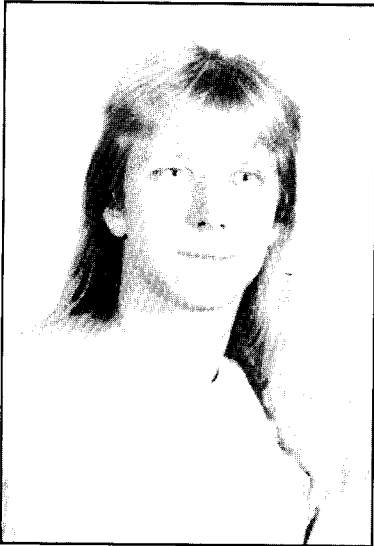

Rowe, Lee



Scales, James



Shannon, Bretina

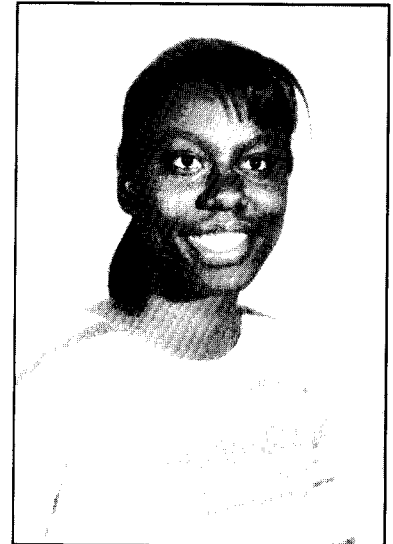

Sims, Alexandria



Sorensen, Brian

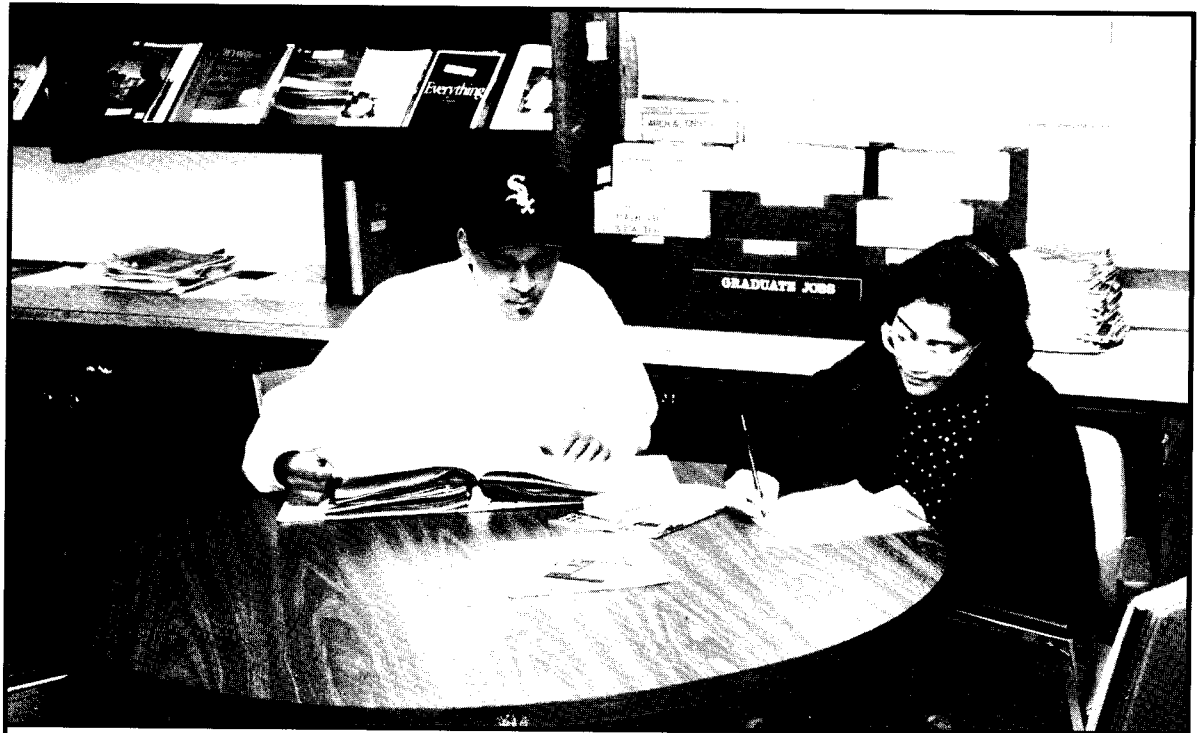

Looking for a job,
anyone would do



Stewart, Charles

Seniors



Thigpen, Lamar



Thomas, Julie

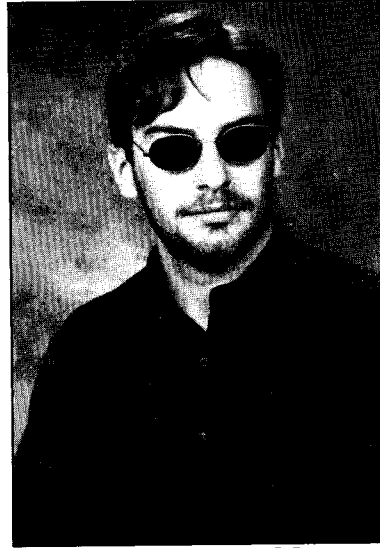

Tidd, Bryan N

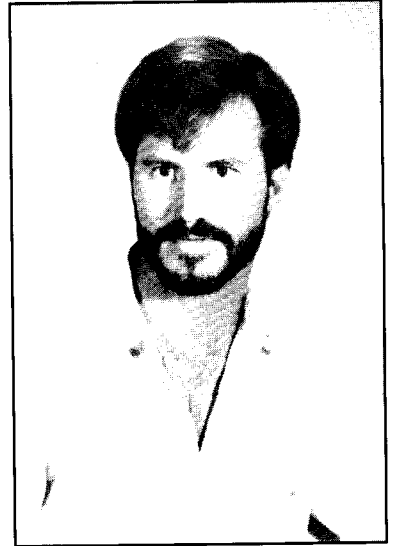

Trotochaud, Timothy



Wade, Mary



Wages, Scott



Waller, Jennifer C



West, Edward

When most people think of Student Publications, they usually view as sort of being a little crazed in the head. Because they usually see us playing computer games, instead of actually doing some homework. If you would look at the big picture on the other page, you will find that some of us did do homework.

Seniors

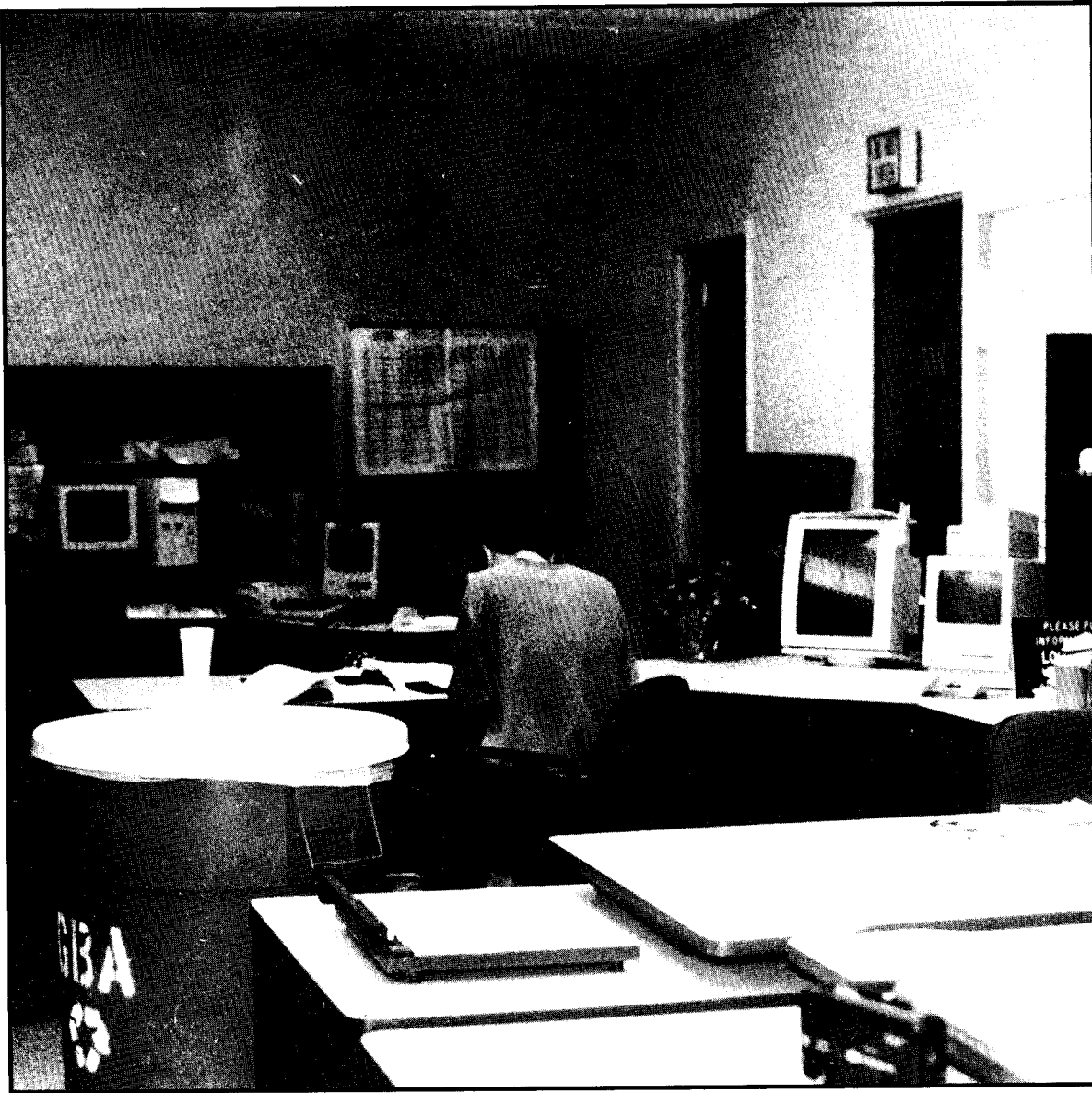

Weldon, Michael

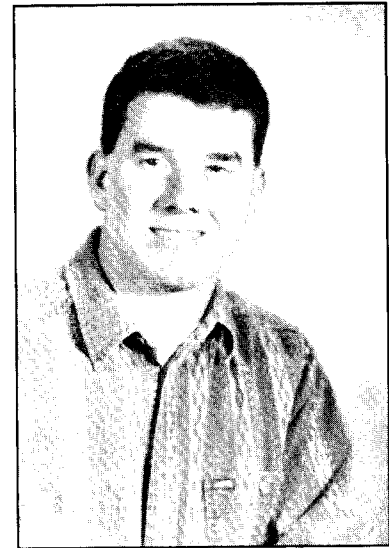

Wetherington, Cary

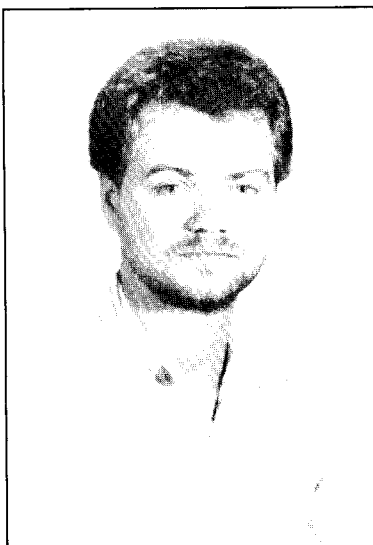

Whitehead, Michael

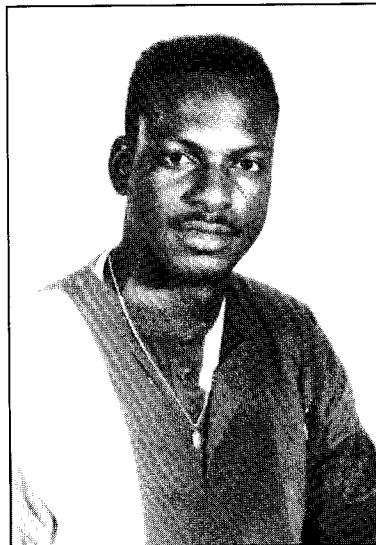

Wiggins, Tony

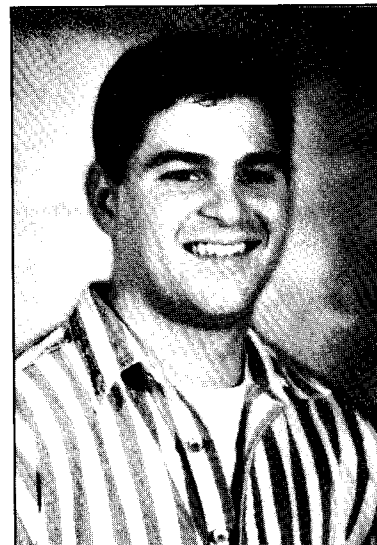

Wood, Charles

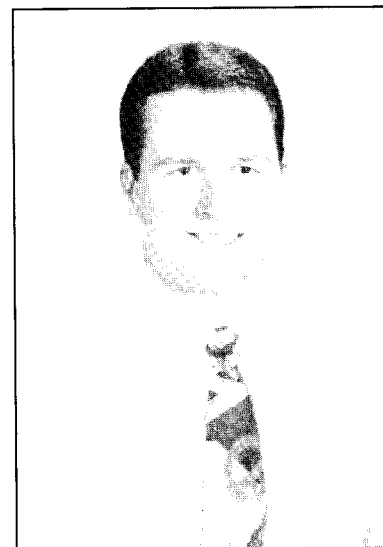

Woodall, Kelly

Undergraduates



Acreman, Shannon



Aleman, Samuel Jr

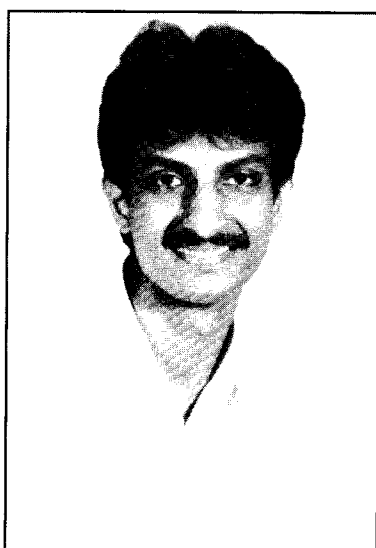

Ali, Rahim Kassam

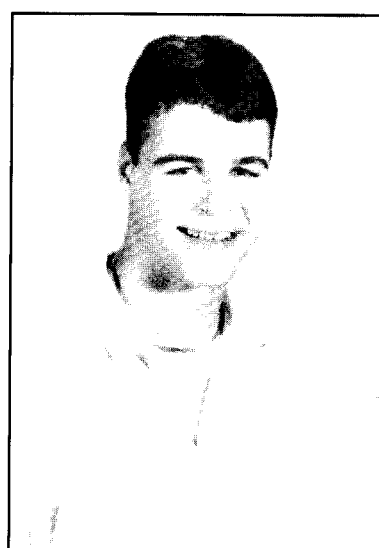

Allen, Matt



Amason, Bitsy



Arnold, Robert



Arain, Sinan

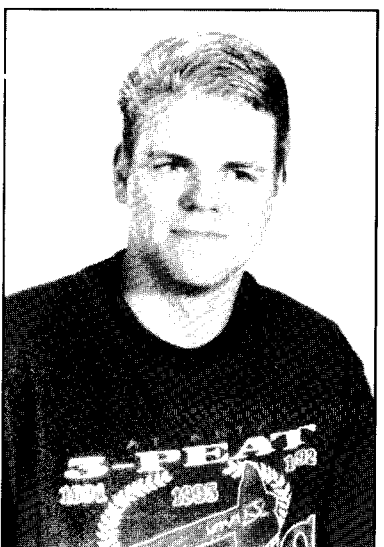

Armstrong, James



Azam, Amir



Baierle, Rob



Undergraduates



Bailey, Michele



Bartley, Kevin

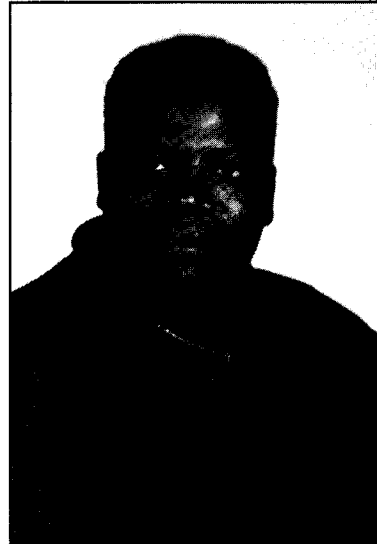

Baskin, Adrian

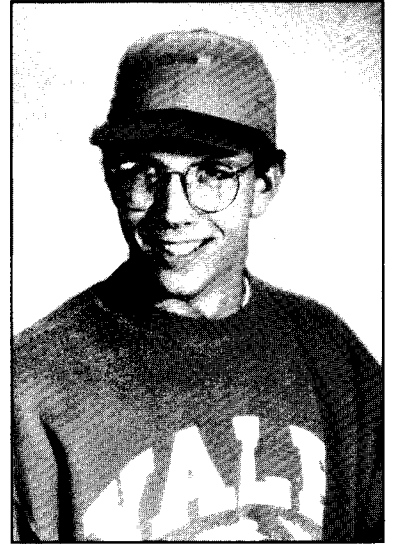

Bennett, Chris

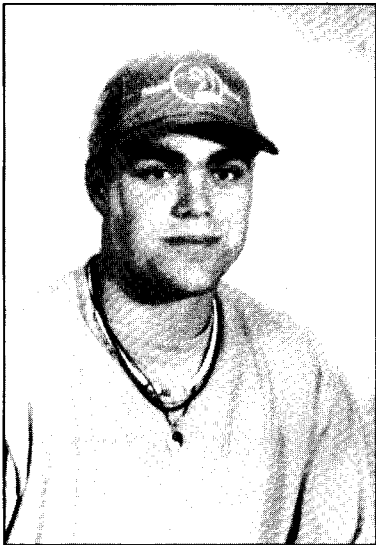

Bingham, Morris

My ultimate dream is to return home. To go back to where I belong. I want to go to home to Falcos III, the fourth planet in the Deterius star system. Many years ago, when I was real young, I was abducted by aliens. The aliens performed experiments on me and fed me awful-tasting food.

After months of captivity by these creatures who resembled brooms, they decided to return me to my planet. Unfortunately, they were also a bit incompetent and got lost in the galaxy. They, therefore, dumped me off, not at my home, but on this planet you call Earth. Since I arrived here, I have always wondered how long I will be exiled here, and every night I would always gaze at the stars (unless it was cloudy) and look at my home.

Yes, my dream is to go home, home to Falcos III, where I can actually fit in.

- TP

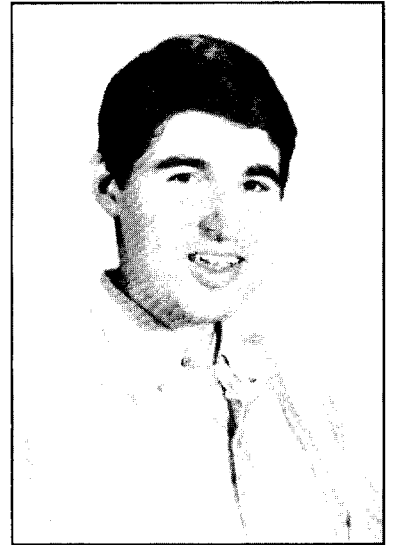

Blumenthal, Matthew



Bonilla, Ricardo

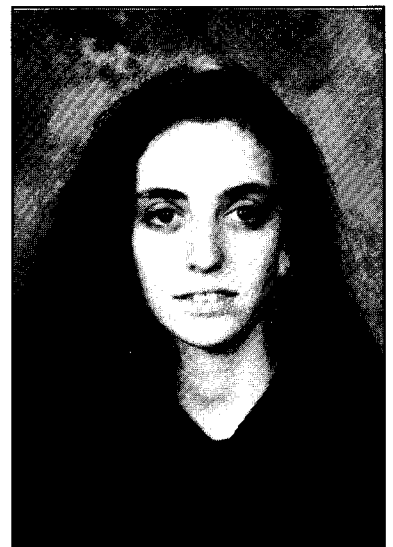

Boros, Leigh A

Undergraduates

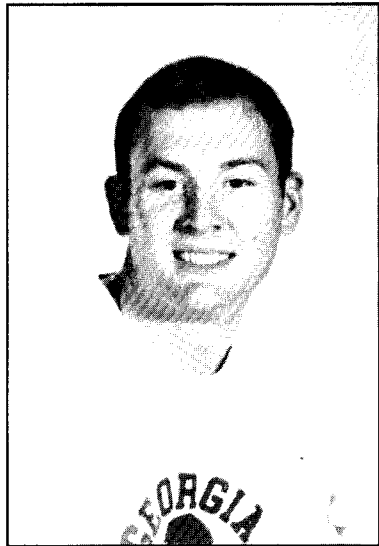

Britt, Mitch



Brown, Flounder

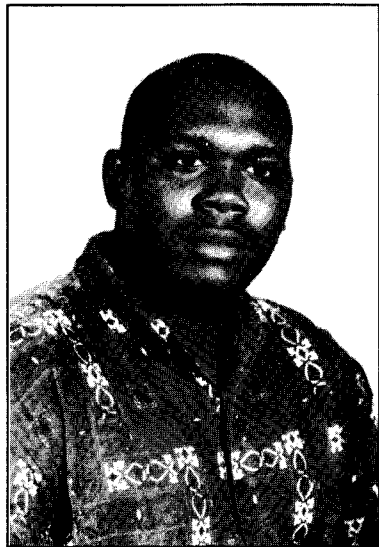
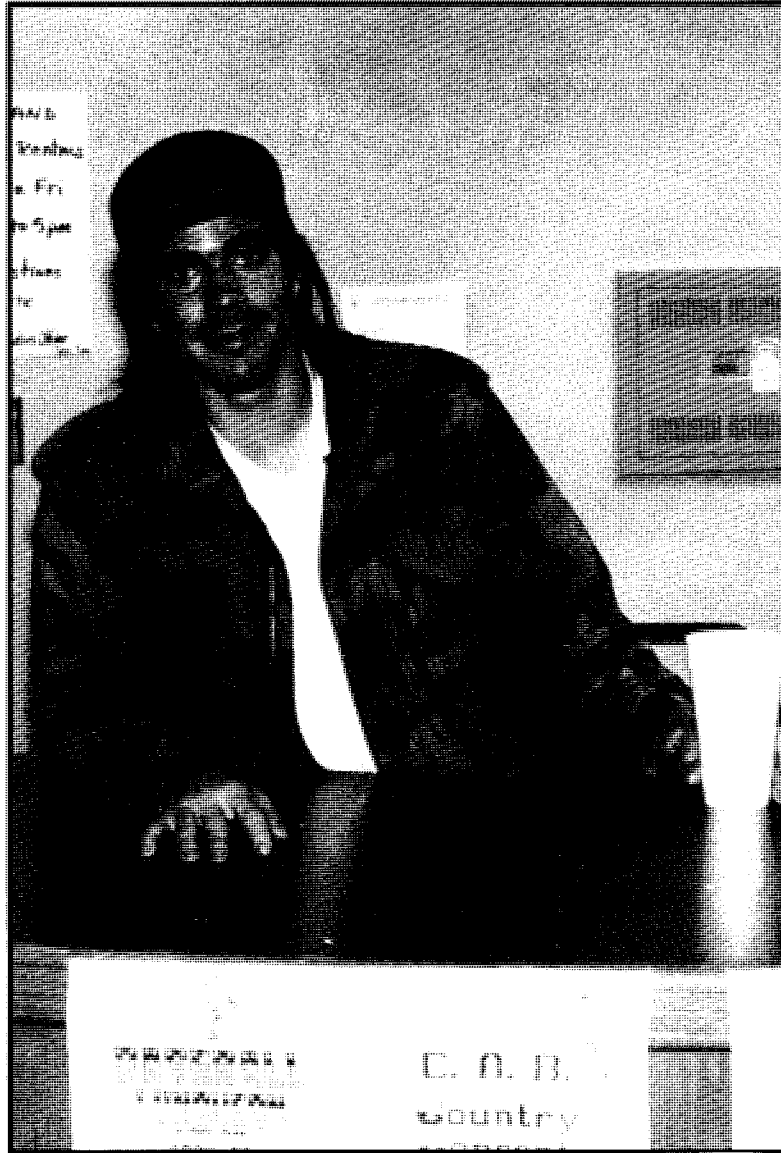

Brown, Shawn

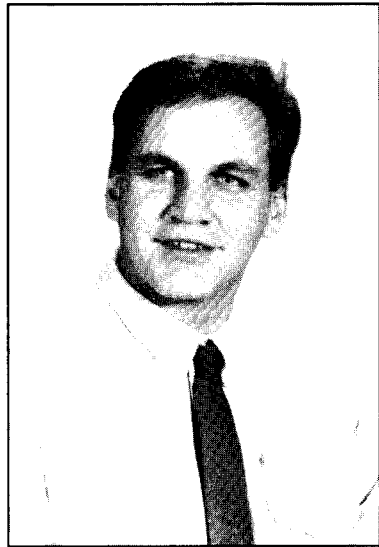

Buchanan, Joshua

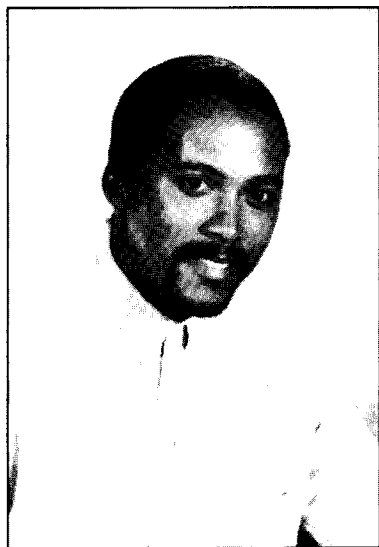

Burchall, Myron



Butler, Andrew

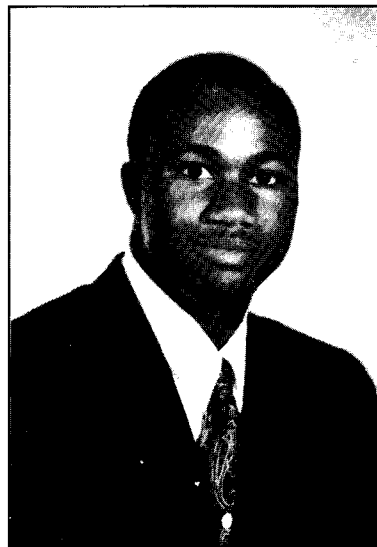

Cantrell, Doc

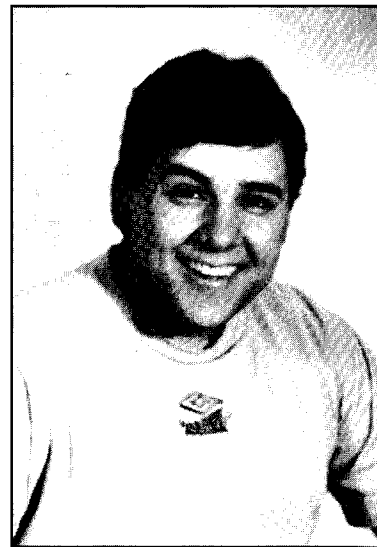

Cardona, Pablo

Undergraduates



Carter, Scott



Childers, Derrick

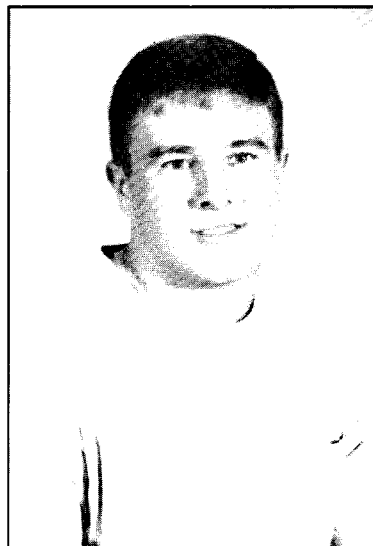

Clifford, Travis



Collins, Phil

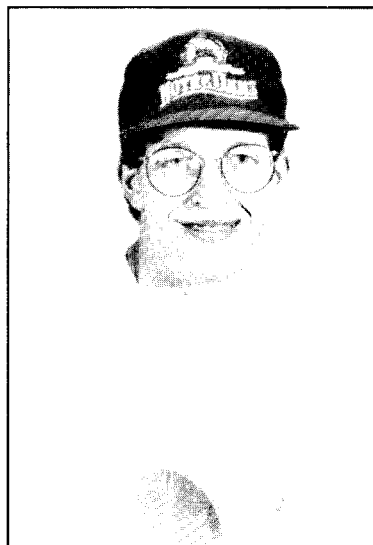

Connell, Charles Jr

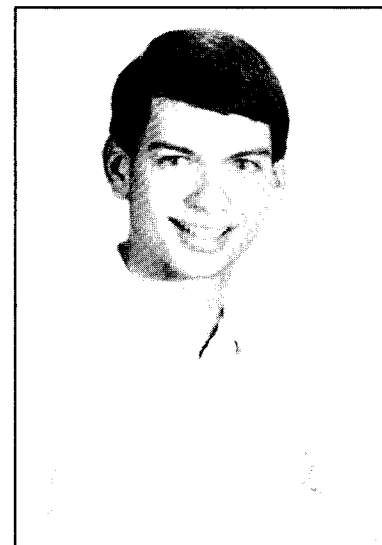

Cordell, Tim



Cox, David

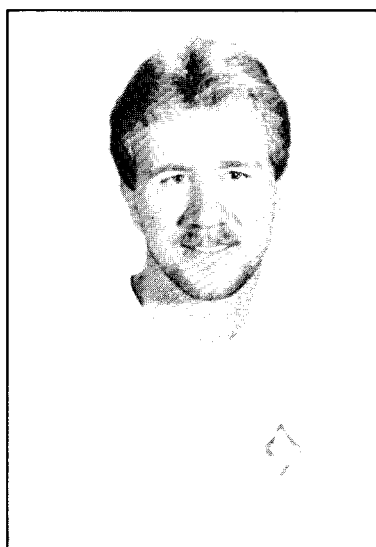

Cox, Ed



Crossley, Cassie

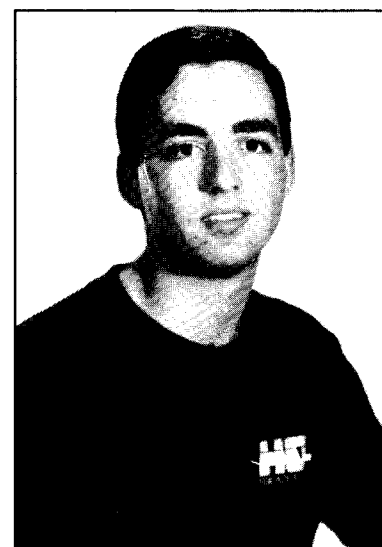

Csanadi, Thomas Jr

Undergraduates

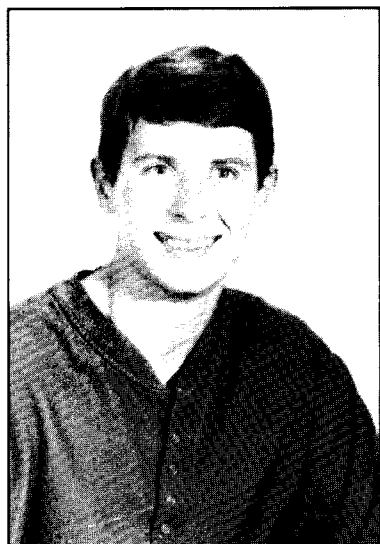

Dansbury, Chris

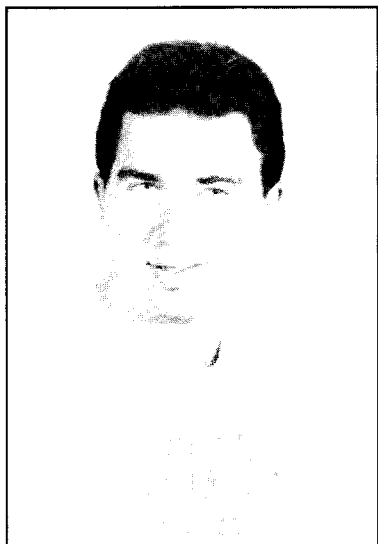

Davis, Curt



Denmark, Tonya



Denton, Keith

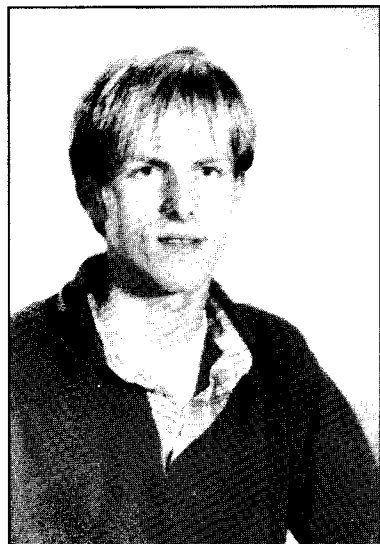

DeSloover, Edward

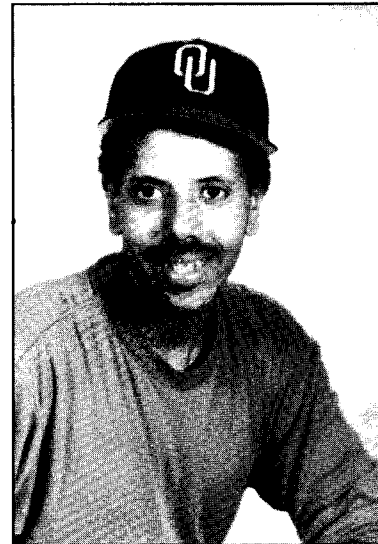
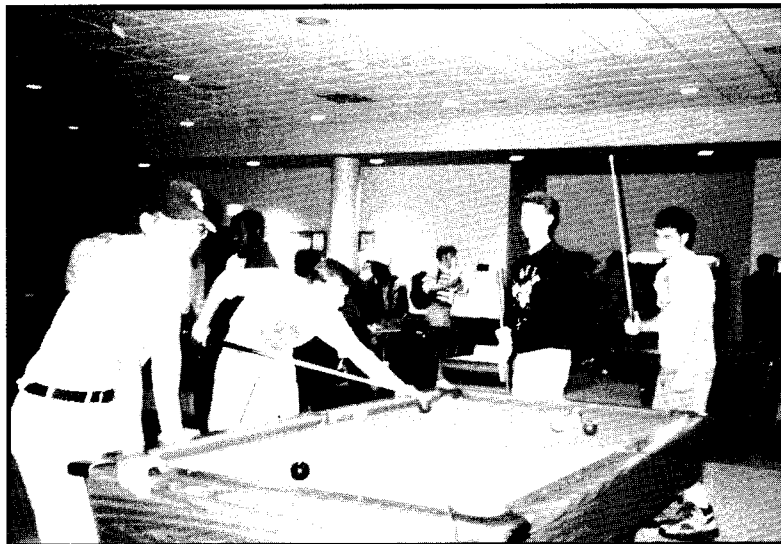

Desta, Mira

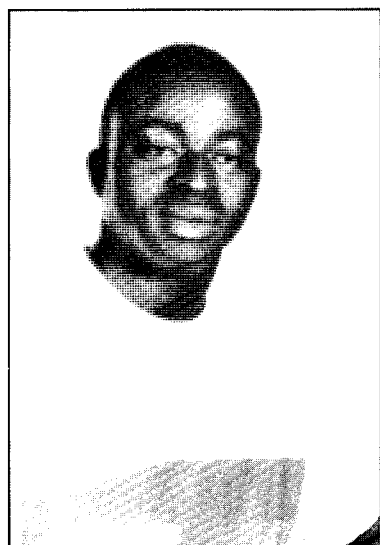

Diaby, Souleymane



Driggs, Clark



Dunn, James

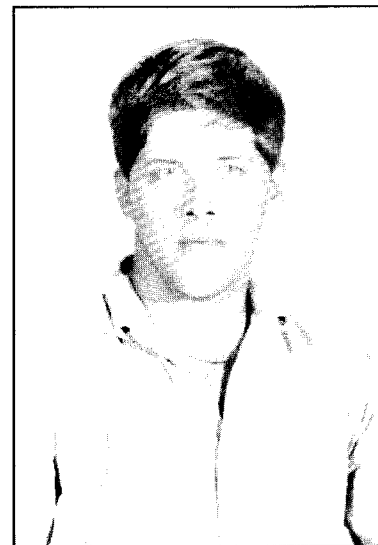

Edwards, Nathan

Undergraduates

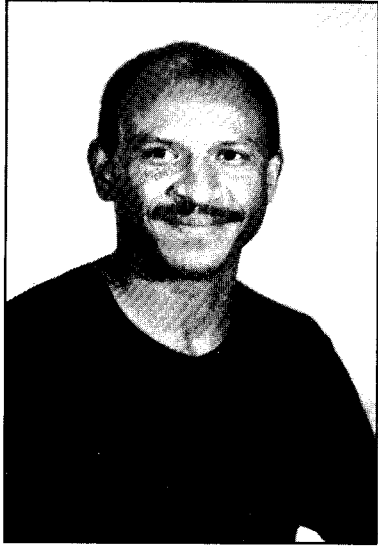

Elbaff, Riyadh

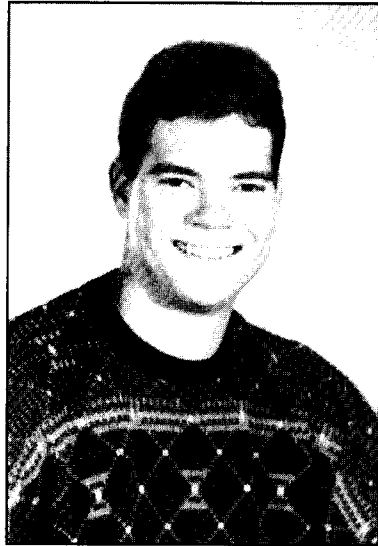

Elliott, Paul

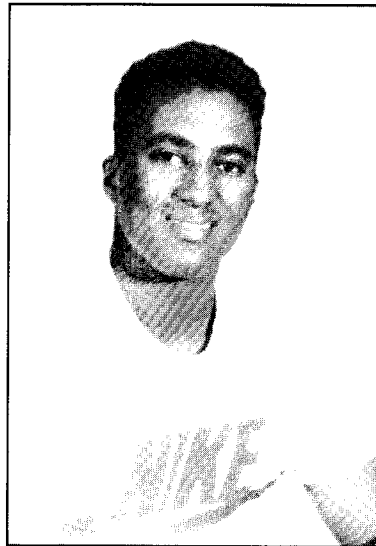

Endirias, Hezekiah



English, Craig

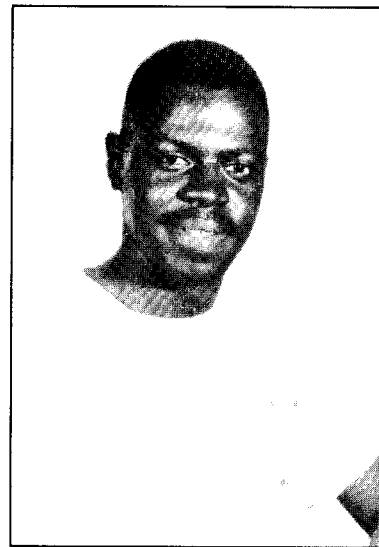

Fain, Kenneth

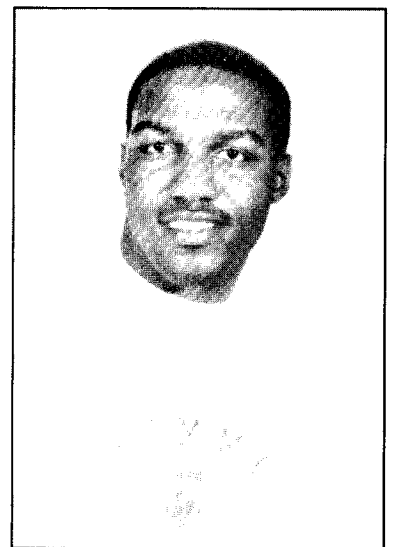

Ferrell, Alejandro



Fields, David



Foster, Brian

Undergraduates



Foster, Macy

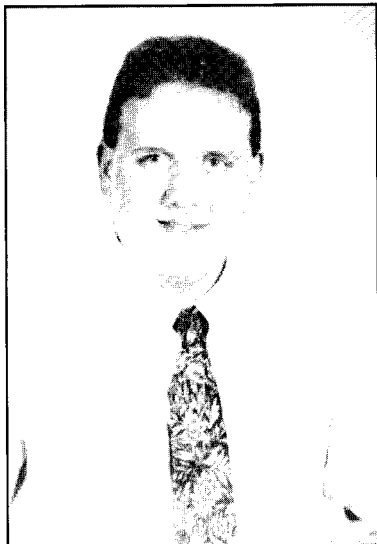

Galli, Dallas

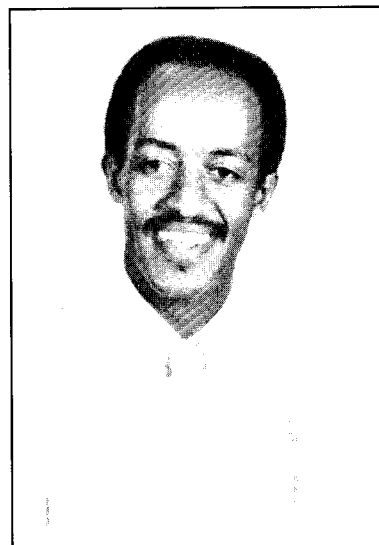

Ghebreyesus, Teodros

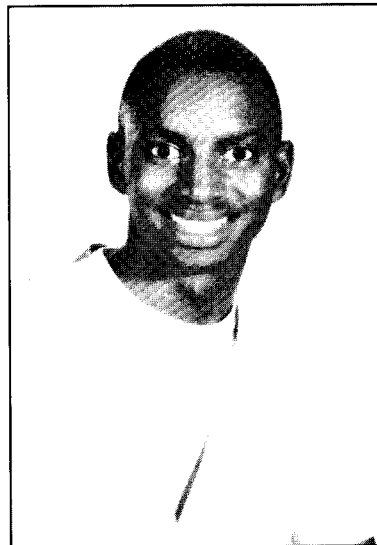

Giles, Arron

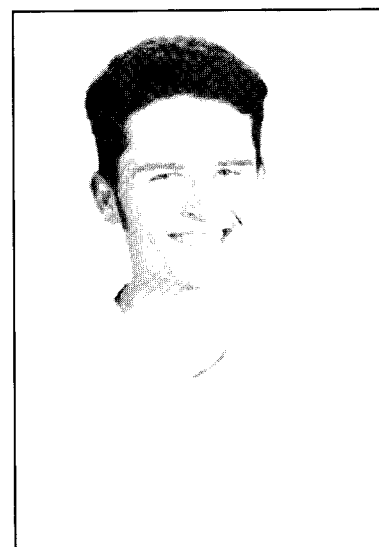

Gill, David

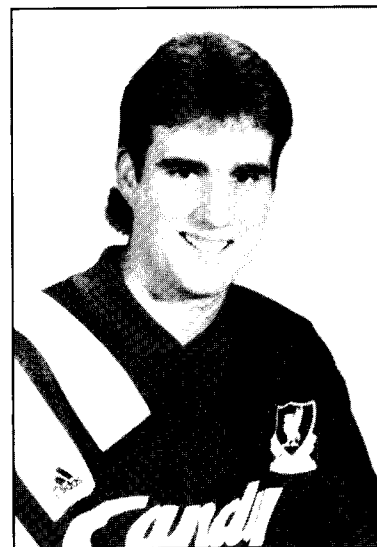

Gorman, David



Undergraduates

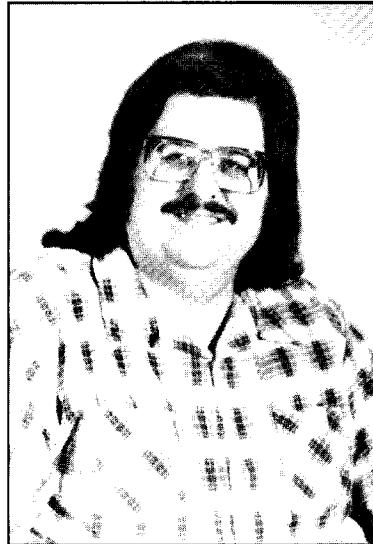

Gosnell, Kenneth

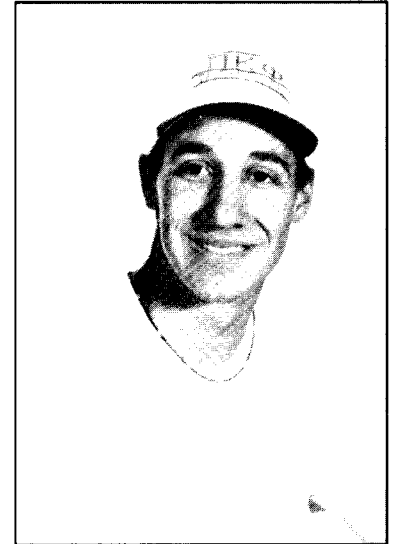

Gospodareck, Louis

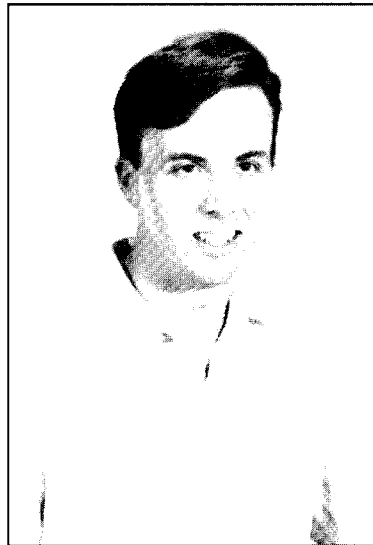

Gouger, Harry



Greene, Dana



Greene, Stephanie



Griggs, Marcia

Undergraduates



Grissom, Jeanna

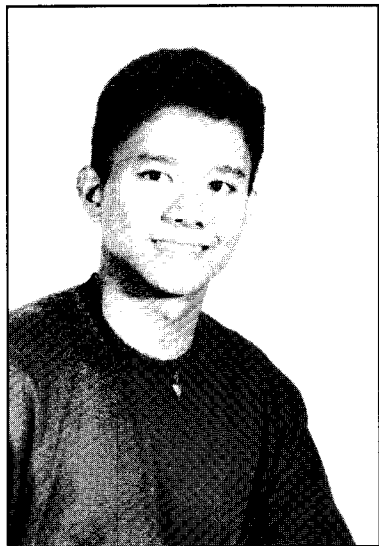

Guzman, Christopher



Hamby, Jon



Hammontree, Tera



Hampton, Derek



Harford, Bo

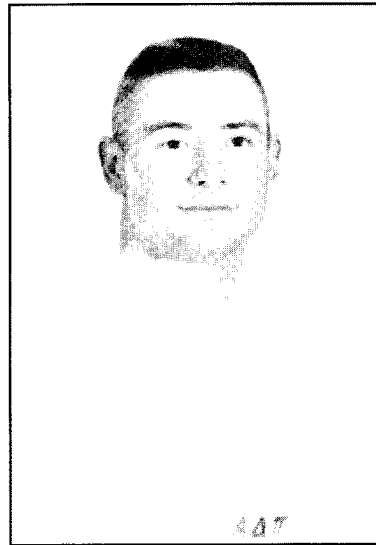

Harper, Mickey

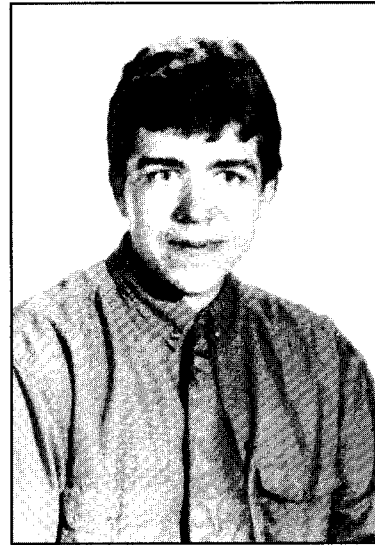

Harrell, Mark



Harris, Stephanie

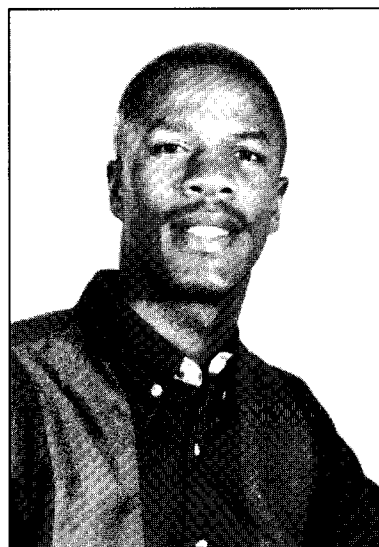

Harrison, Kevin



Heath, John

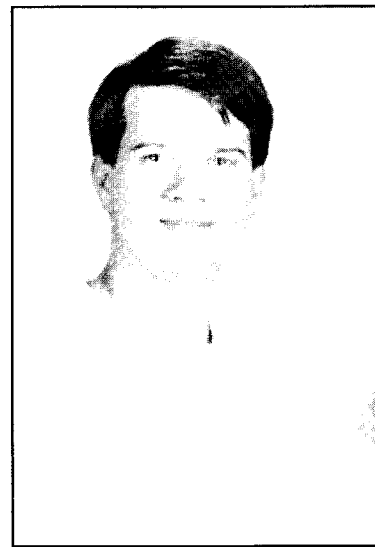

Hefner, Shawn

Undergraduates



Hoawell, Nicola



Holmes, Gerald



Holton, Leigh

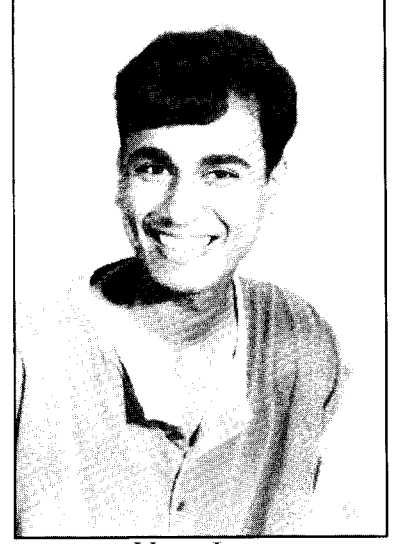

Huq, Isan



Jarnagin, Wendy

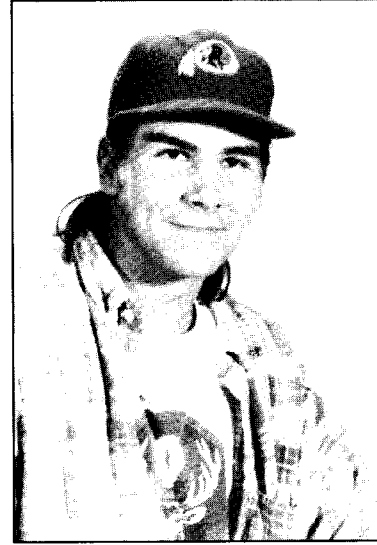

Ivie, Heath



Jactson, Dennis



Jarnagin, Wendy



Jefferson, Roxanna

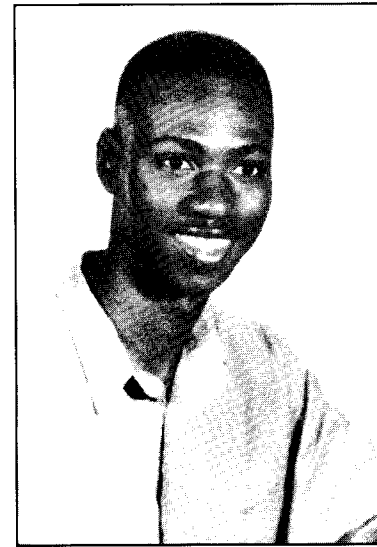

Johnson, Christopher



Johnson, Latanya

Undergraduates



Johnson, Robert

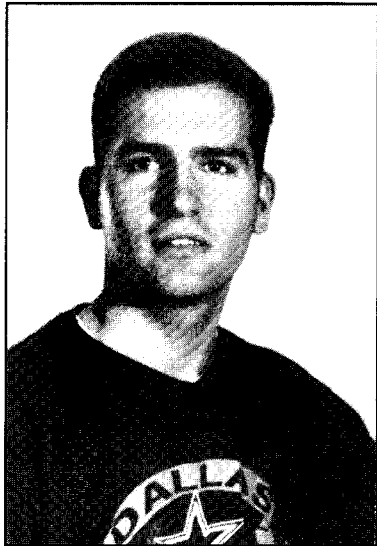

Johnston, William



Joiner, Raymond

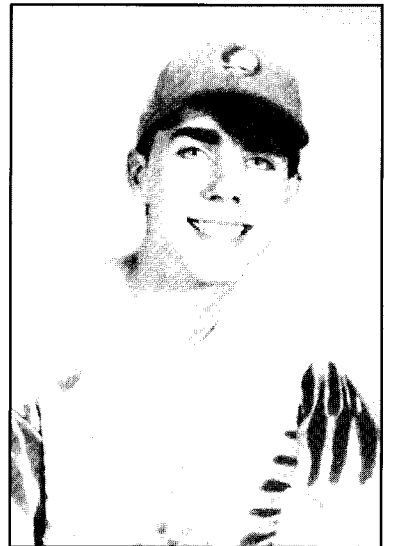

Jordan, Travis

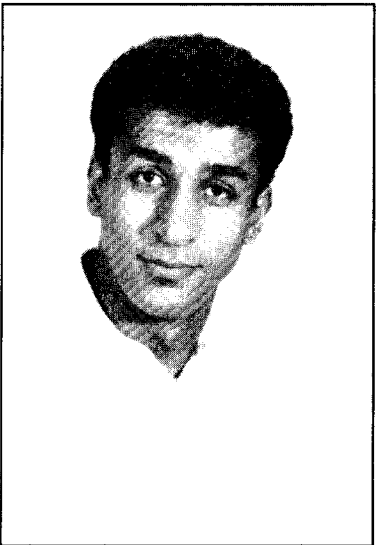

Karrazzi, Zakk

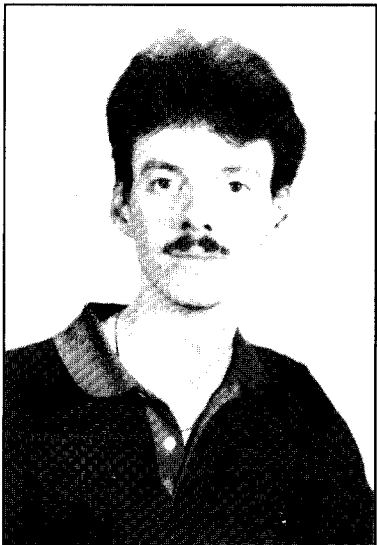

Keels, Thomas



Kelley, David



Kennedy, Cedric



Kennington, Brian

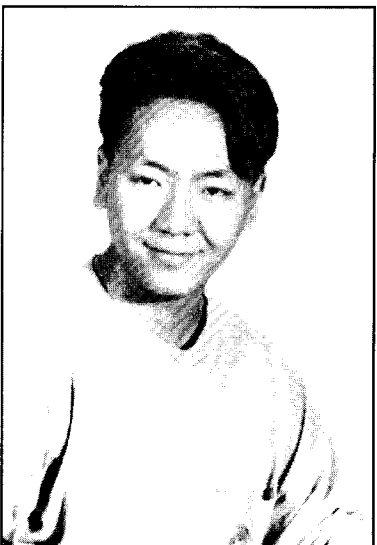

Kim, Sunny

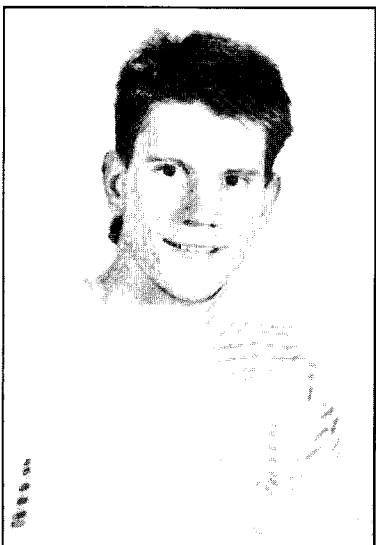

Kurz, Scott

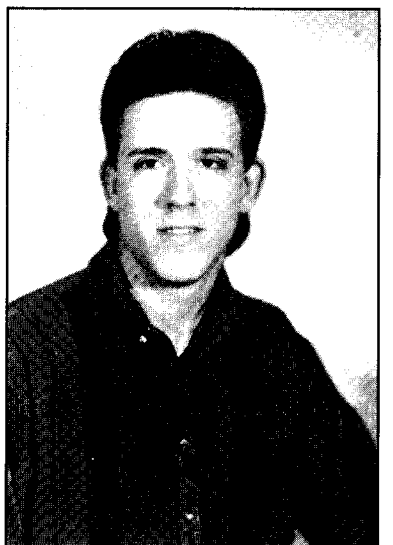

Labbe, Lawrence

Undergraduates



Lane, Mari



Leboy, Melinda

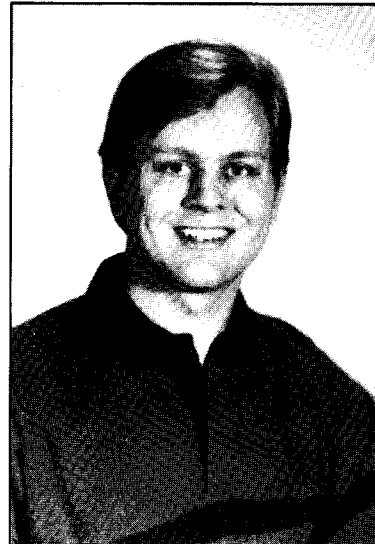

Leftwich, Kevin

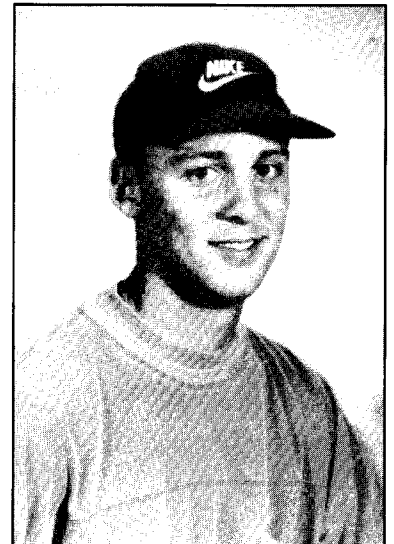

Locklear, Chad

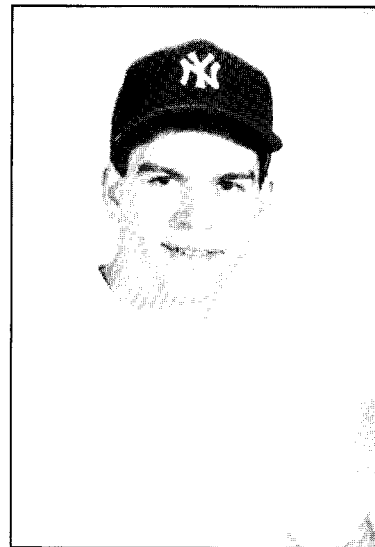

Lockridge, Russell

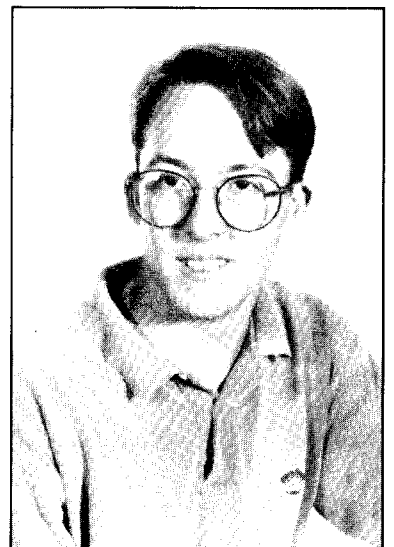

Long, Jason

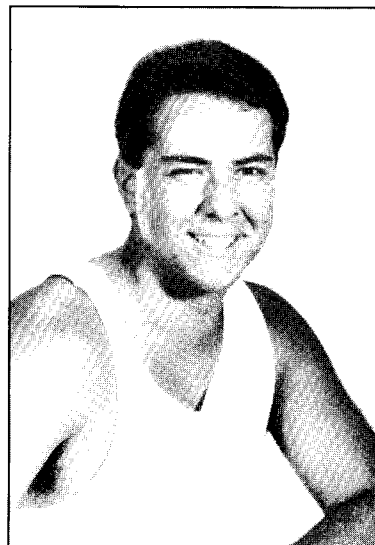

Lorenzo, Eddie

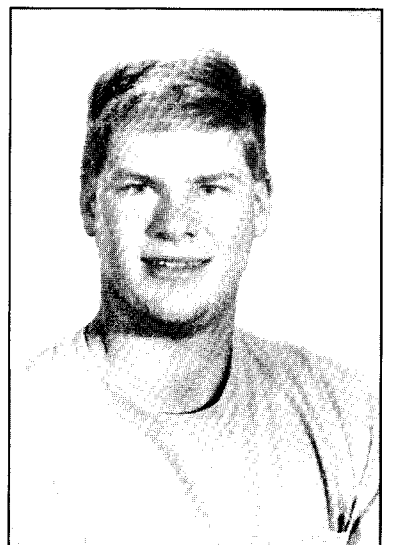

Lumpkin, Travis

Undergraduates

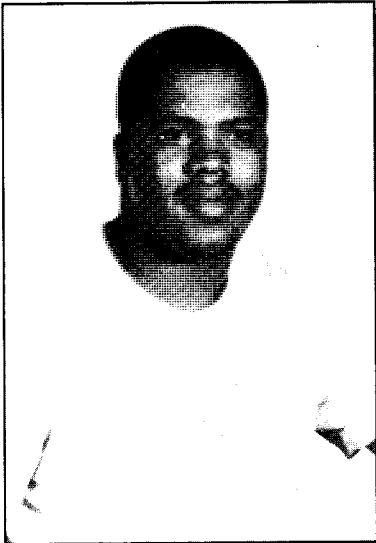

Mackey, Makario



Maddox, Sharon

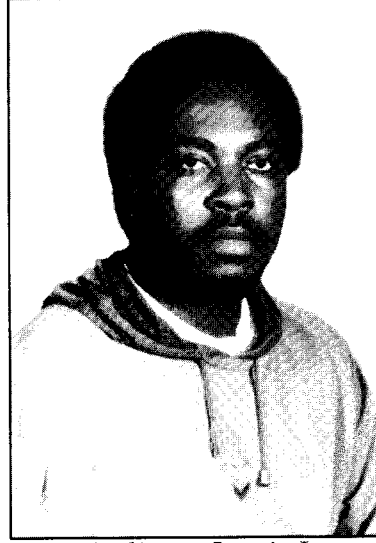

Madison, Louis Jr



Madrerohon, Charles



Maness, Legrand Jr



May, Patrick



Mays, Kafi

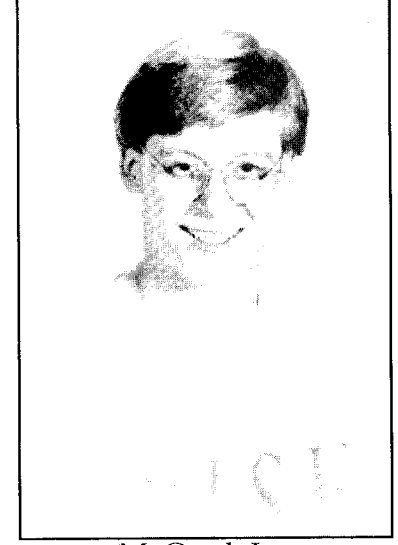

McCord, Joe



McKinney, Charmaine



McLeRoy, Dee

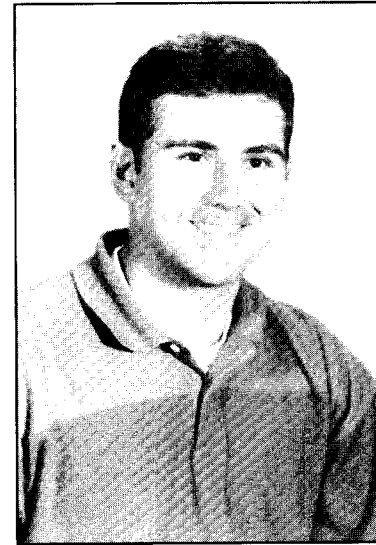

McQuagge, Stuart

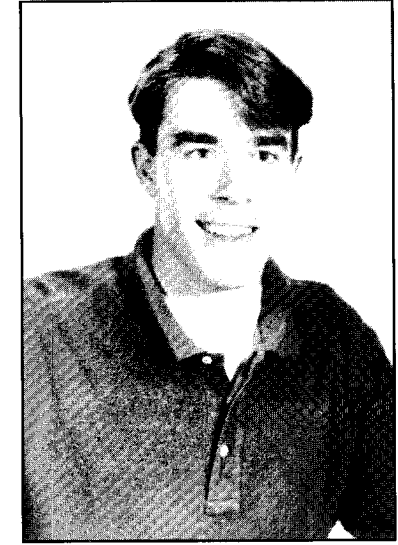

Meitz, Jon

Undergraduates

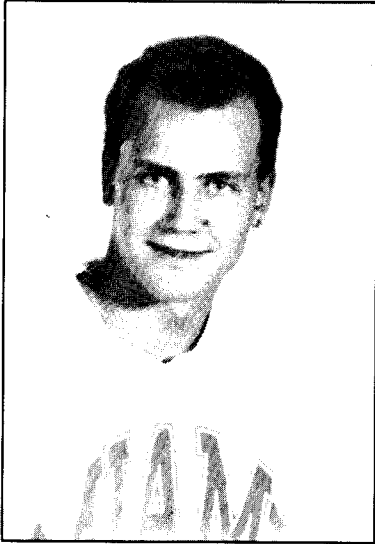

Merrell, Clint

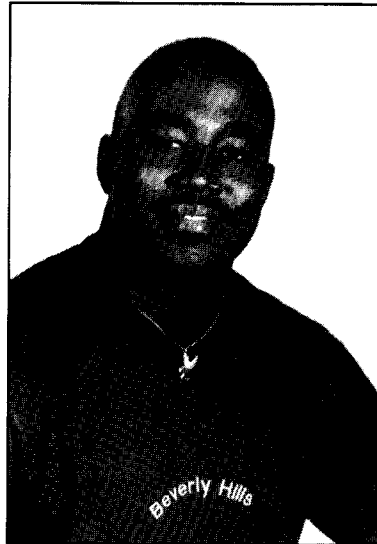

Miller, Mark

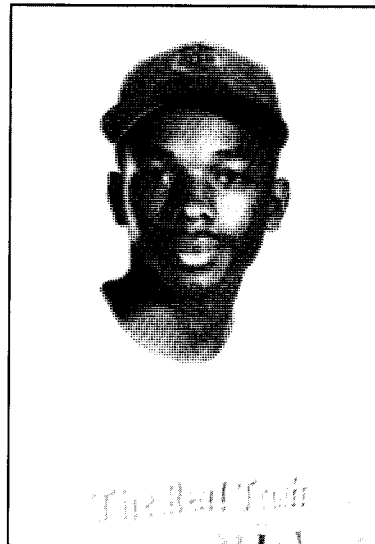

Moran, James

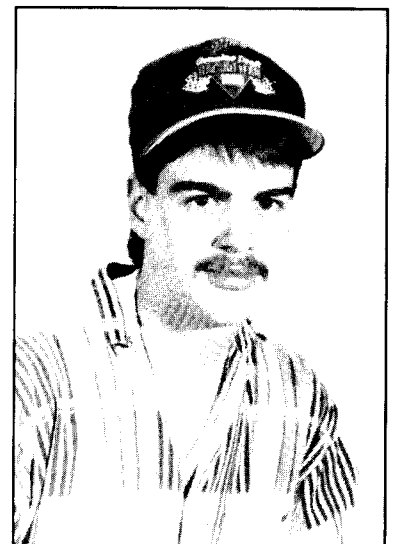

Morgan, Robby

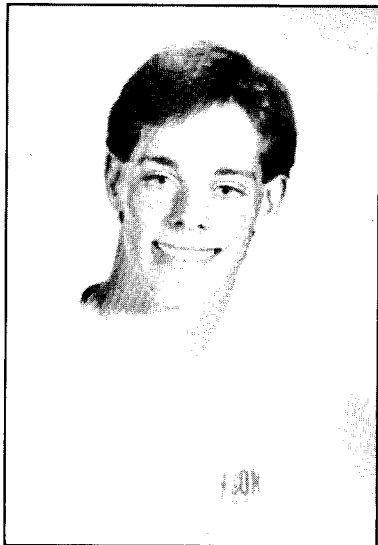

Munder, Eric

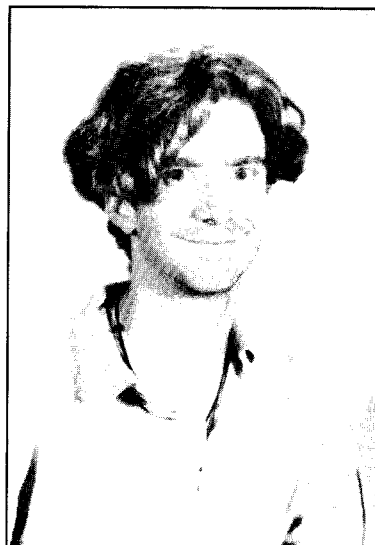

Oakes, David

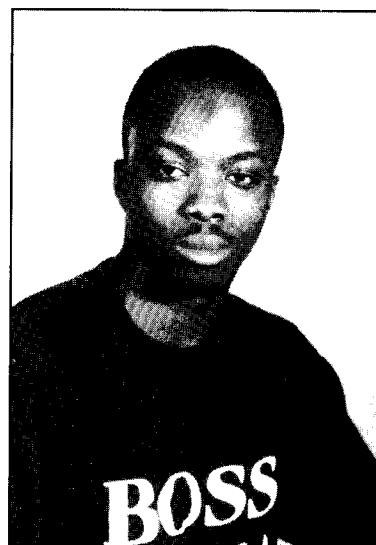

Oglesbee, Gene Jr

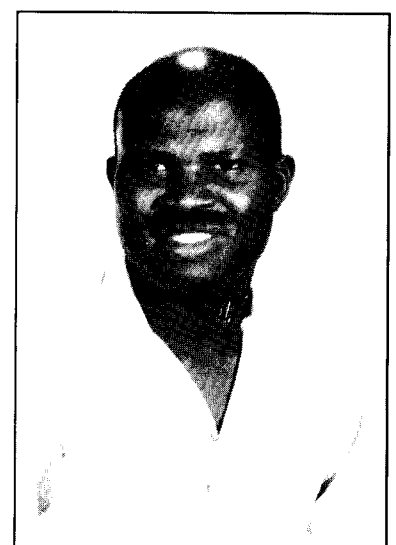

Orishanivi, Johnson



Ortiz, Nestor



Osborn, Denise



Otey, Stephen



Overton, Brian

Undergraduates

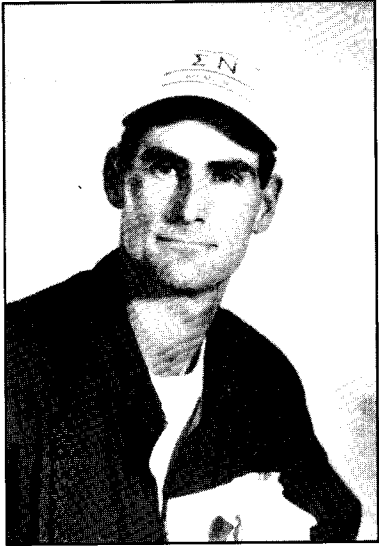

Ownby, James

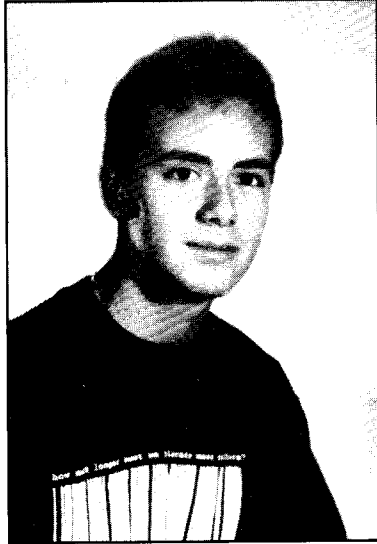

Pajores, Osear

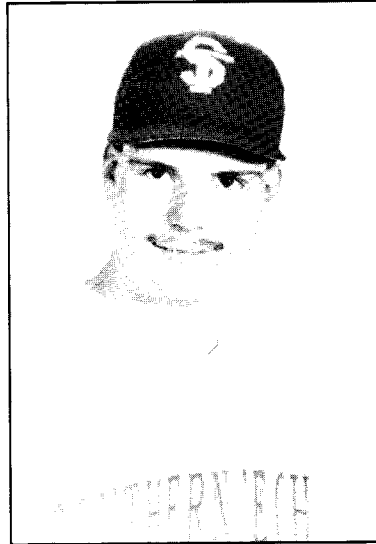

Patterson, Nathan



Payne, David



Perides, Angie



Pinilla, Rosita



Plumlee, David



Pontzer, Matthew

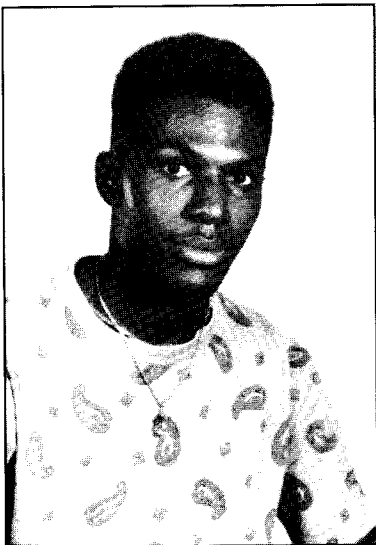

Powell, Boysie III

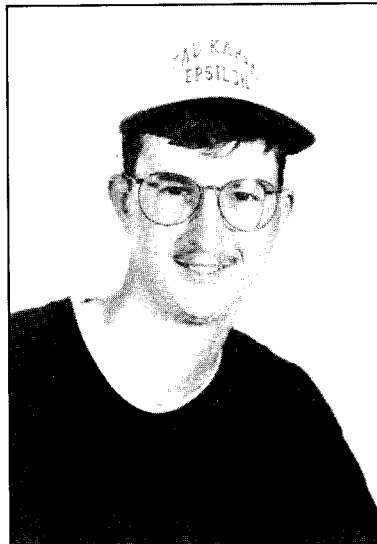

Power, David

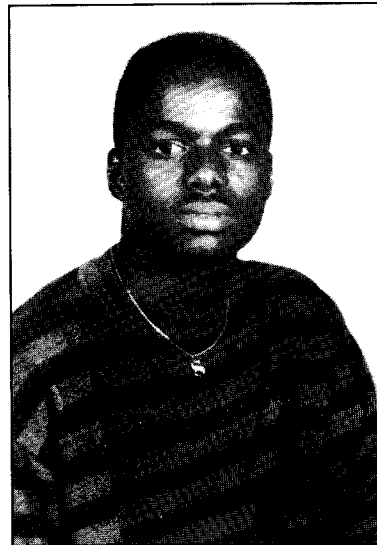

Poyce, Shimada



Purcell, Kevin

Undergraduates

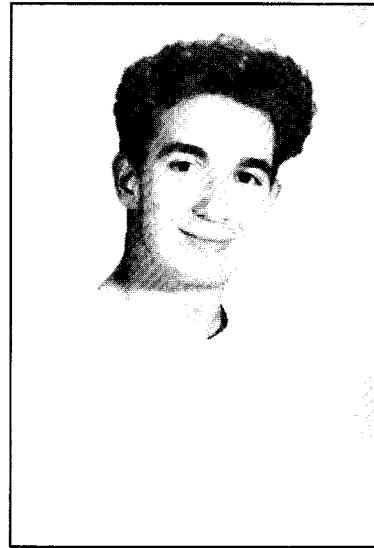

Quattlebaum, Joshua

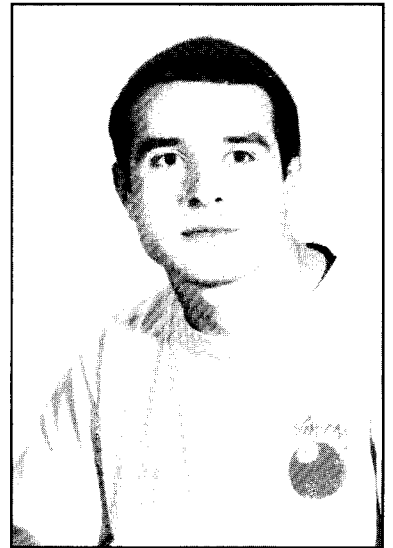

Quijano, Michael

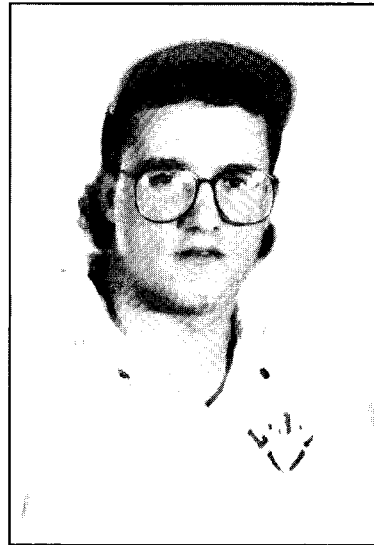

Raupp, Harry

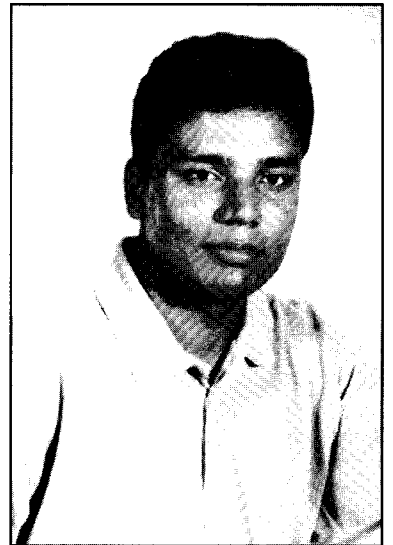

Raza, Choudhary

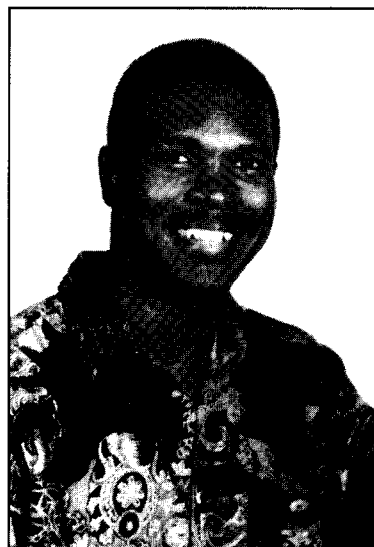

Reese, Michael

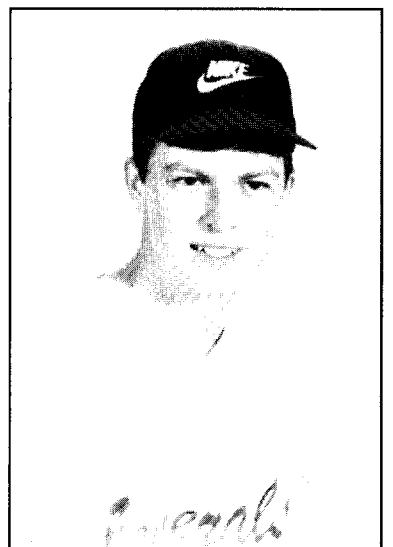

Redwine, Jacob

Undergraduates



Rogers, Chante'

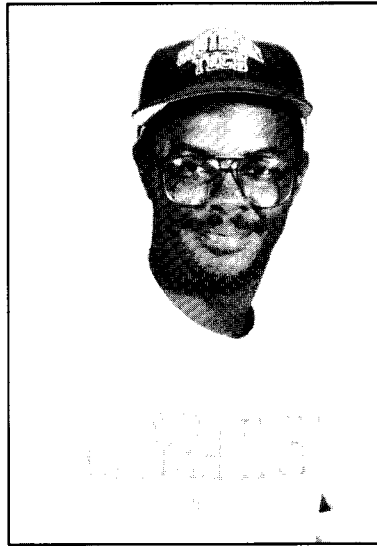

Roman, Marcus

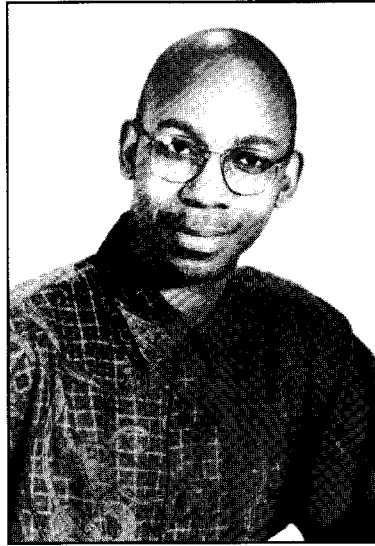

Rowe, Derrick



Rud, Larry



Russell, Vaughn



Saenz, Michelle



Scheufler, David

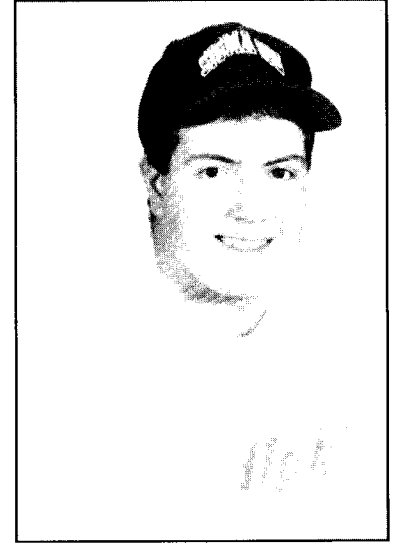

Schmidt, Jaon



Schuler, John

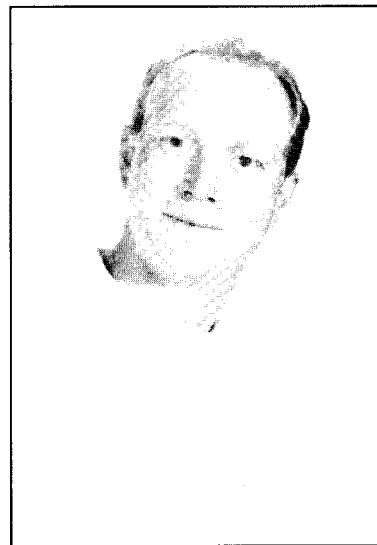

Scott, Joe



Seals, LaToya

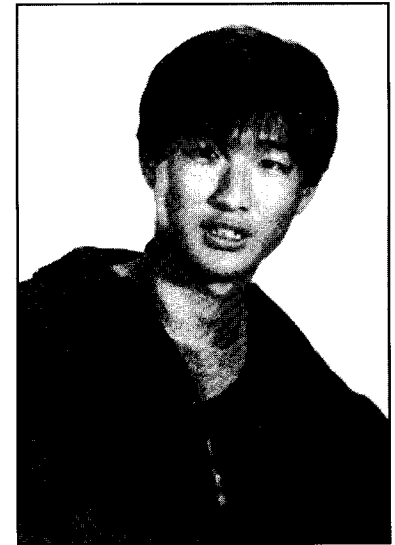

Seo, Juhyon

Undergraduates



Shaikh, Irfan

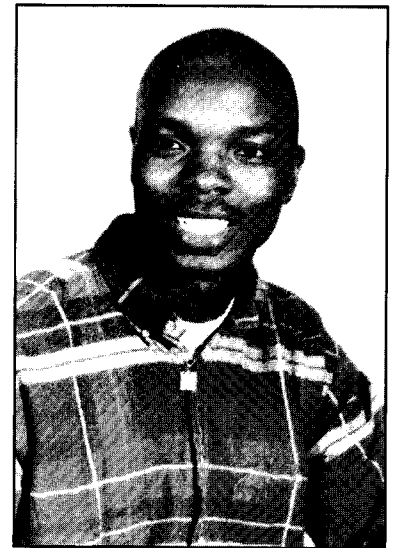

Shelton, Kenneth

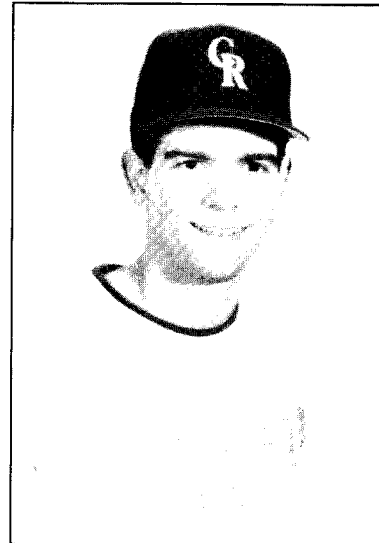

Shipman, Chris



Siddiqui, M Imran



Smith, Brian



Smith, Chad



Smith, Charles

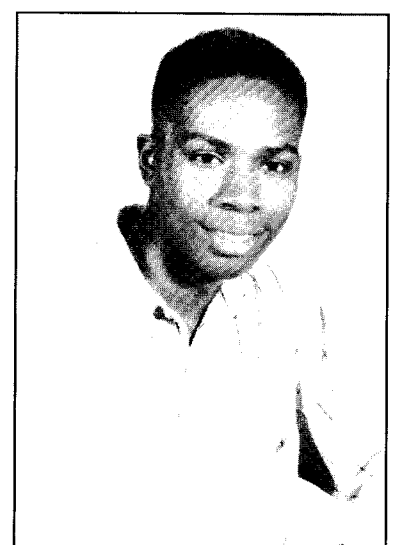

Smith, Derrick

Undergraduates



Smith, James

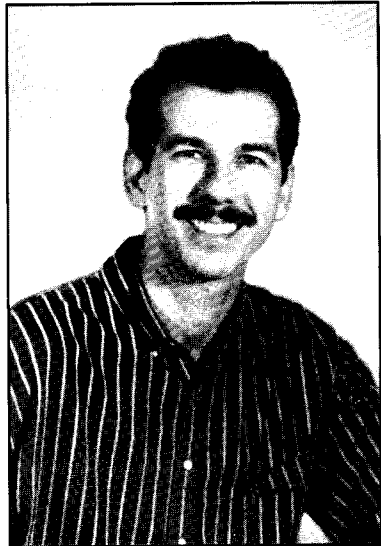

Smith, Ray



Sterling, Robert

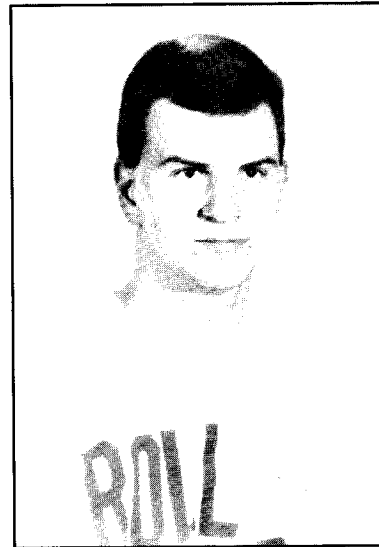

Stewart, William

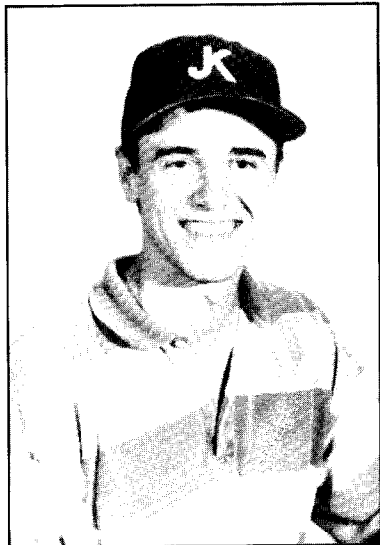

Stover, Jeremy



Stowers, Rebecca



Studevart, Mirhonda

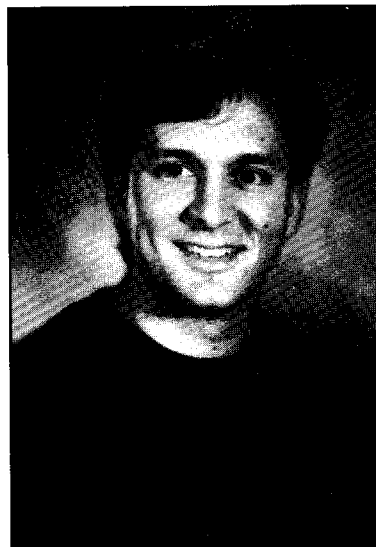

Stuler, Wayne

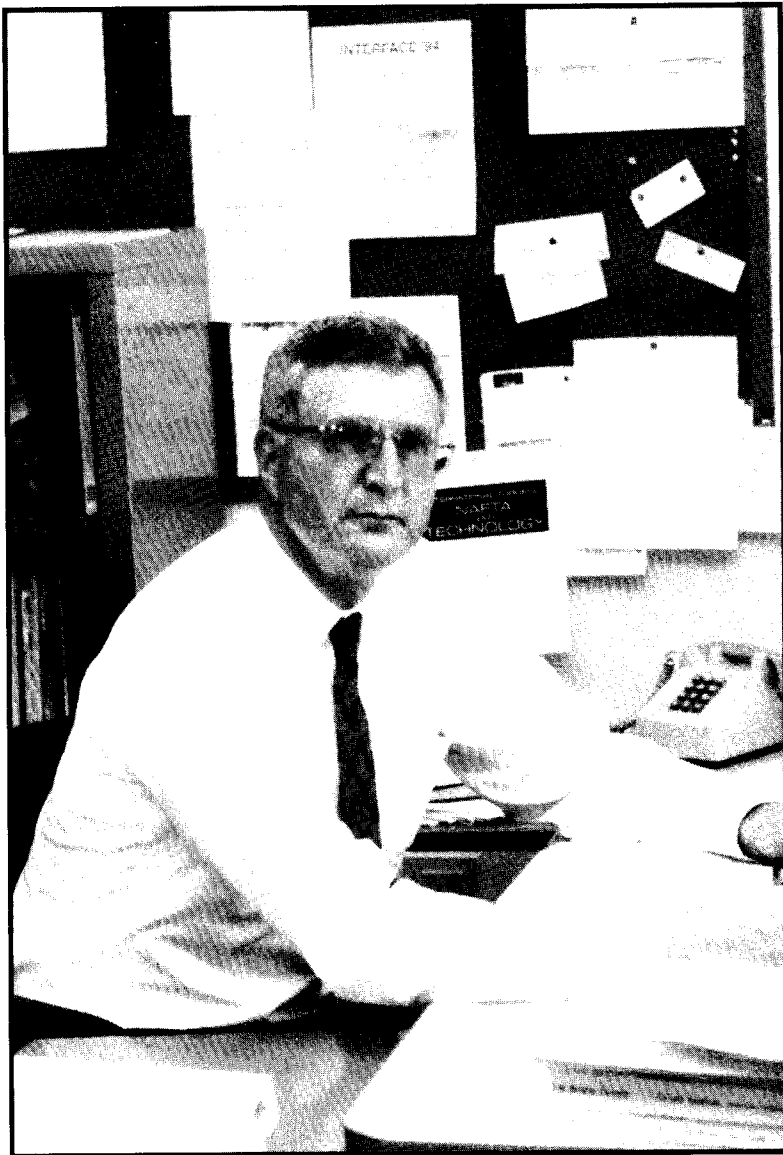

Undergraduates



Taylor, Orin

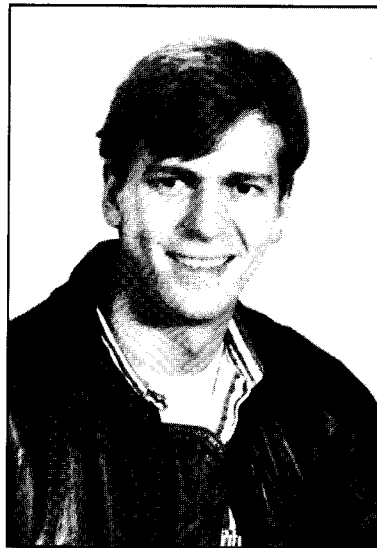

Temple, Brent

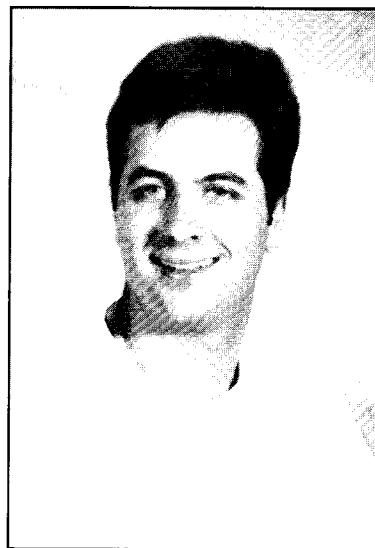

Thibodeau, Rob



Thomas, Edward



Tirevold, Greg

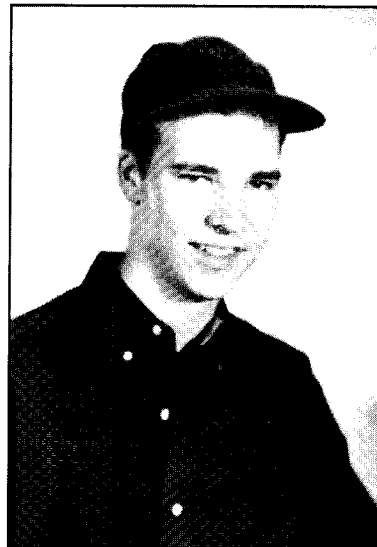

Touchstone, Rob

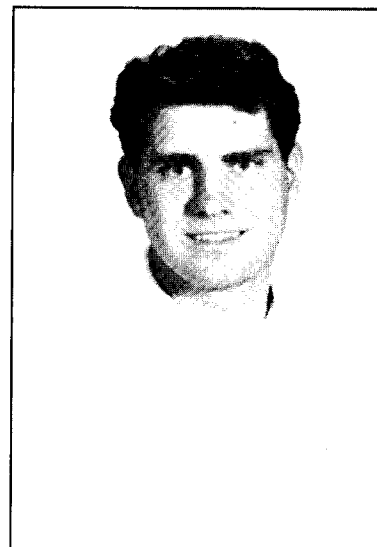

Truett, Allen

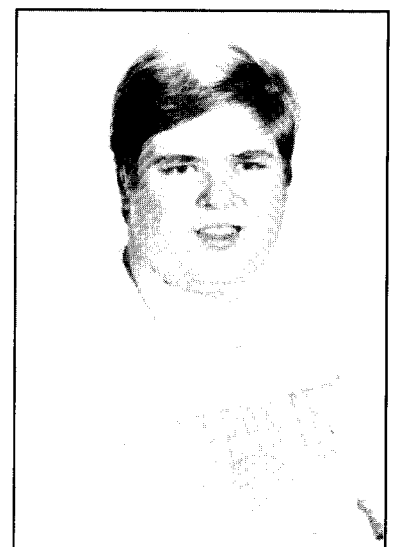

Tunget, Joe



Usserey, Jonathan

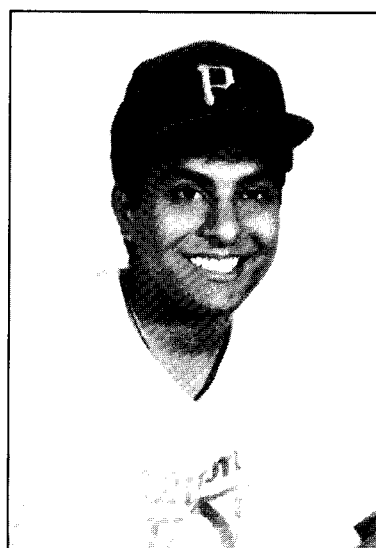

Vaghmar, Jamir

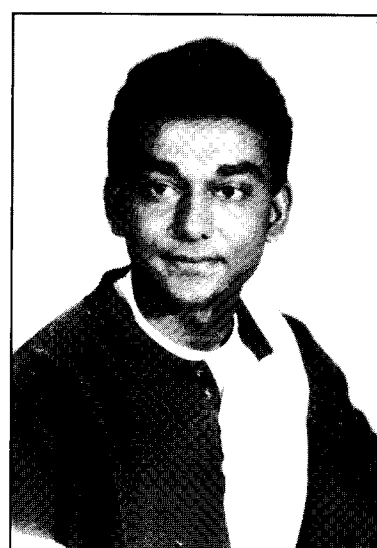

Vashi, Miki

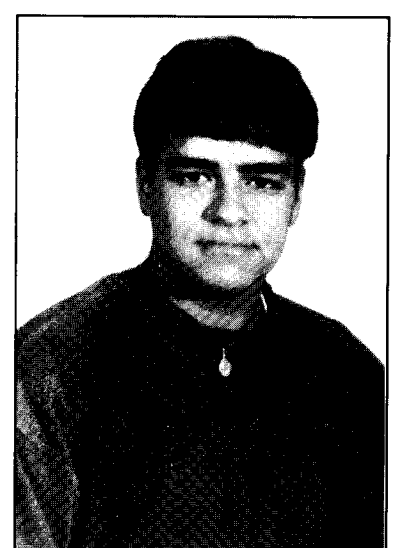

Wade, Robert

Undergraduates

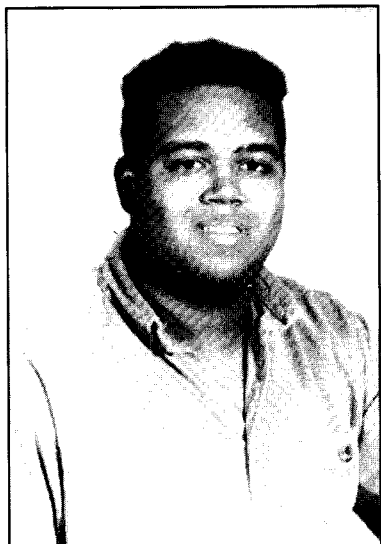

Wagstaff, Robin



Waldo, Todd

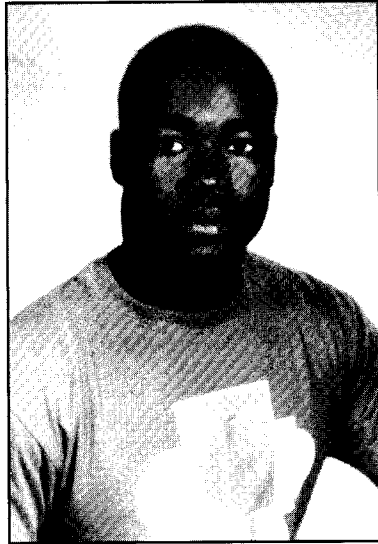

Walker, Julian

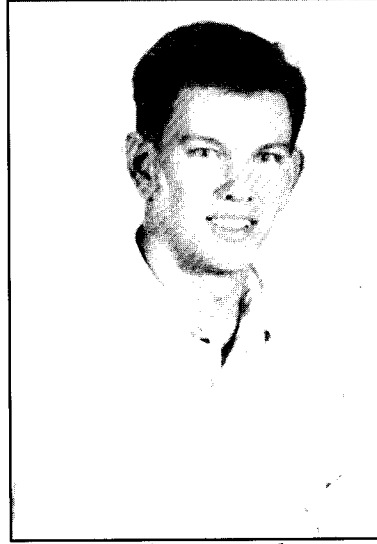

Walton, Mark



Watkins, Anthony



Webster, Kevin



Wells, Sean



West, Chinika

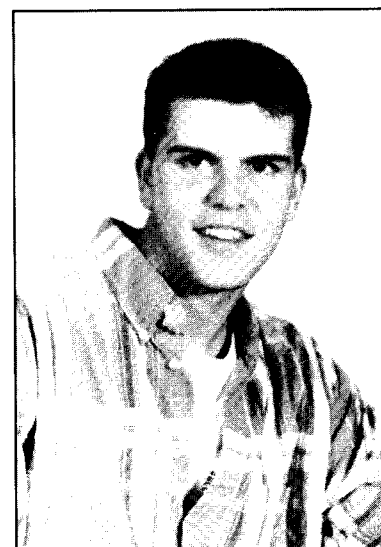

Weston, Bill



White, Jennifer

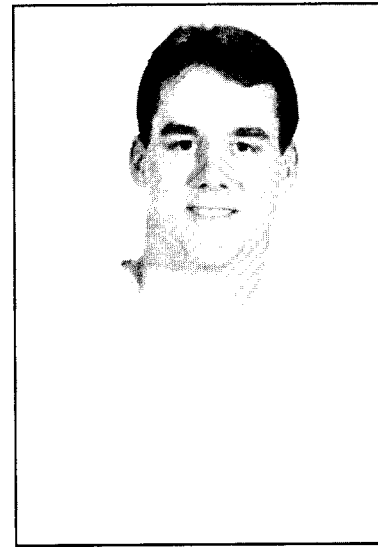

Whitfield, Ben

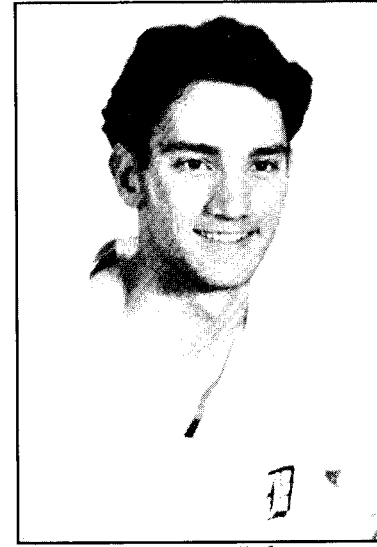

Wiggins, John

Undergraduates

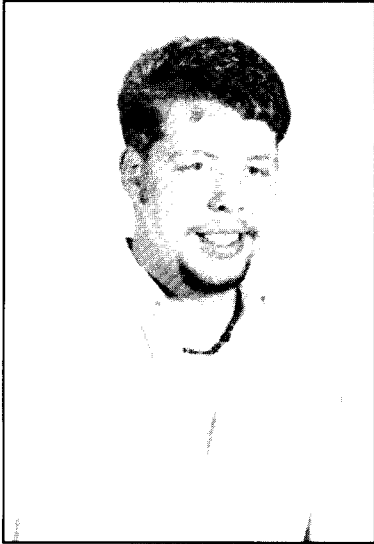

Wilkes, Jay

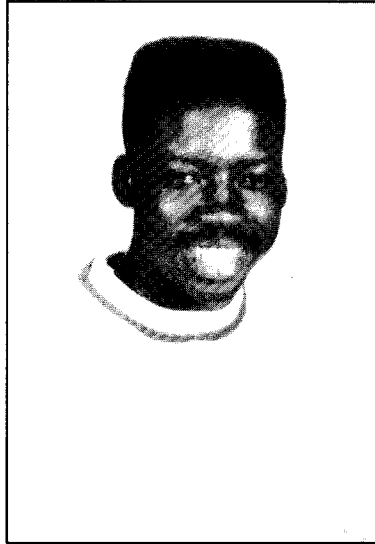

Wilkey, Ronald



Willis, Andre'

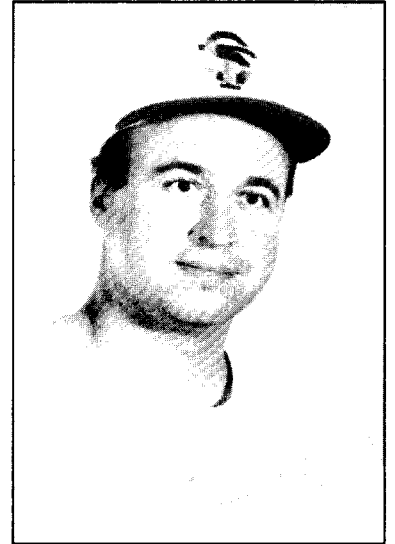

Wilson, Kinney



Wolfe, Scott



Wysong, Brian

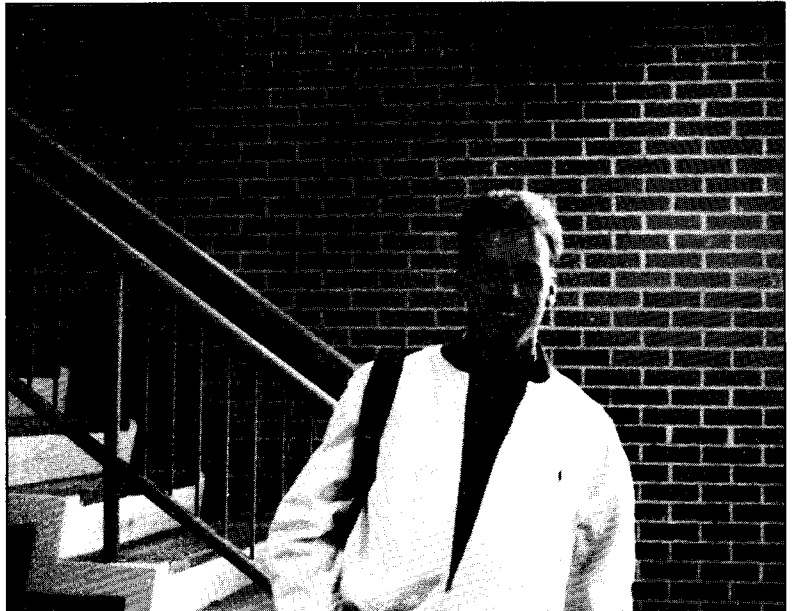

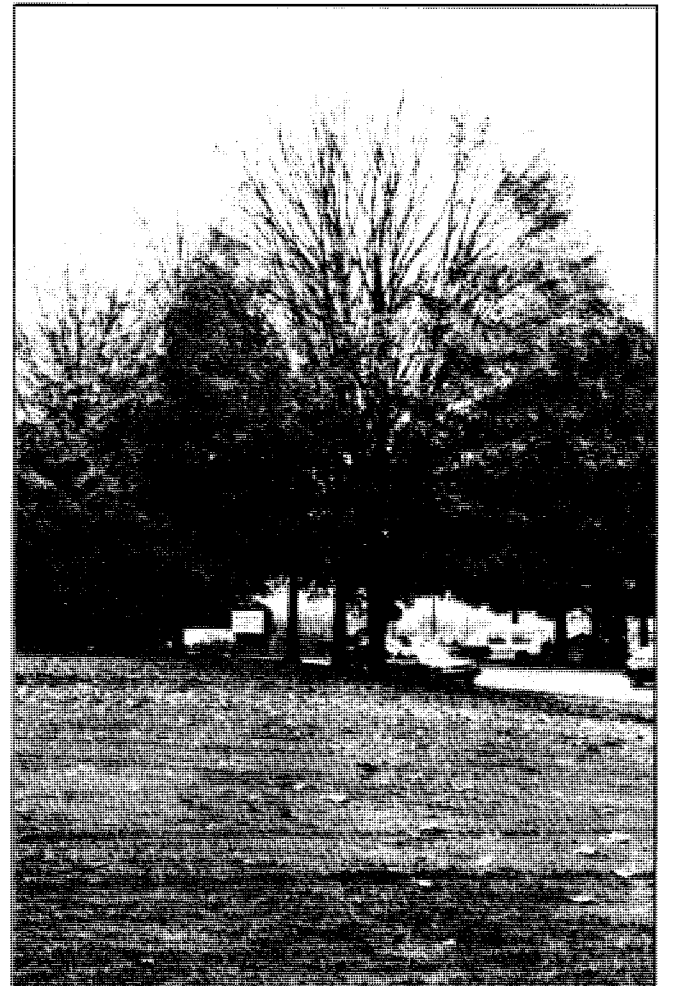
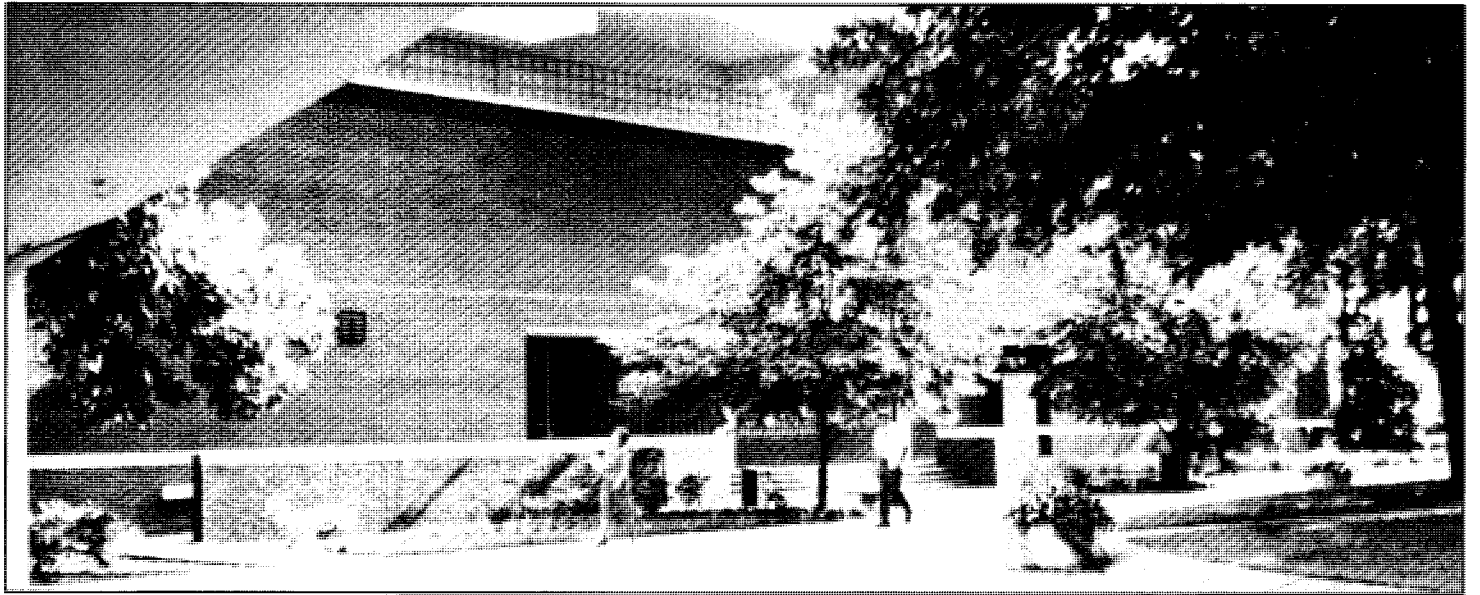



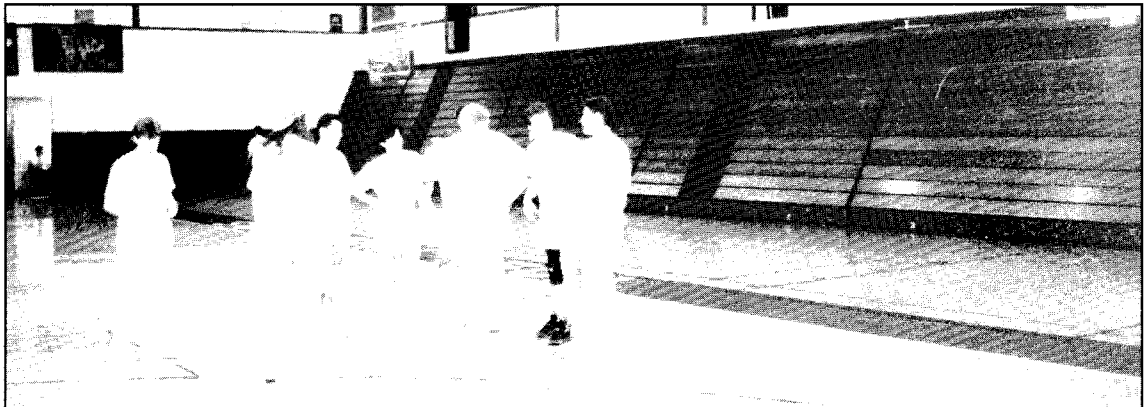
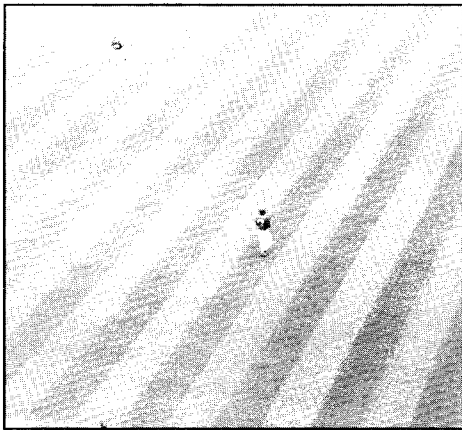
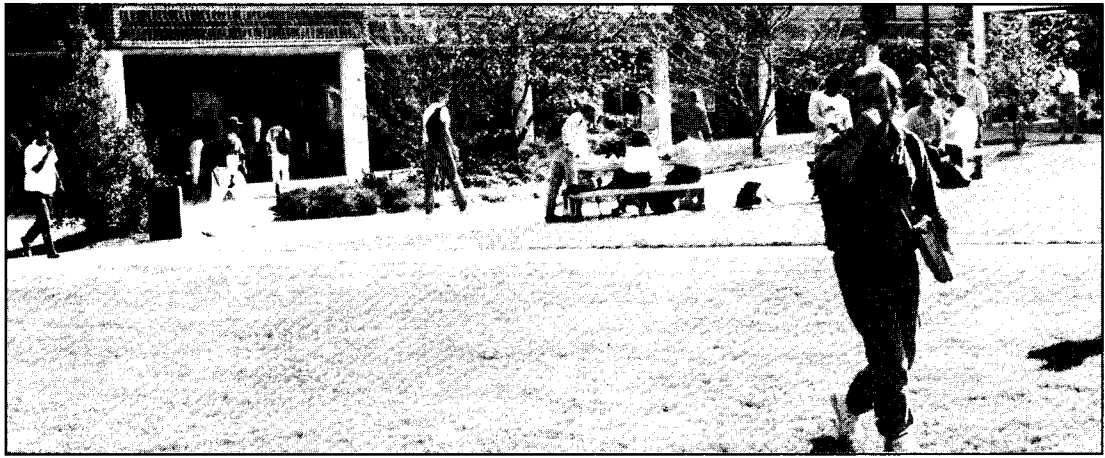

FACULTY AND STAFF

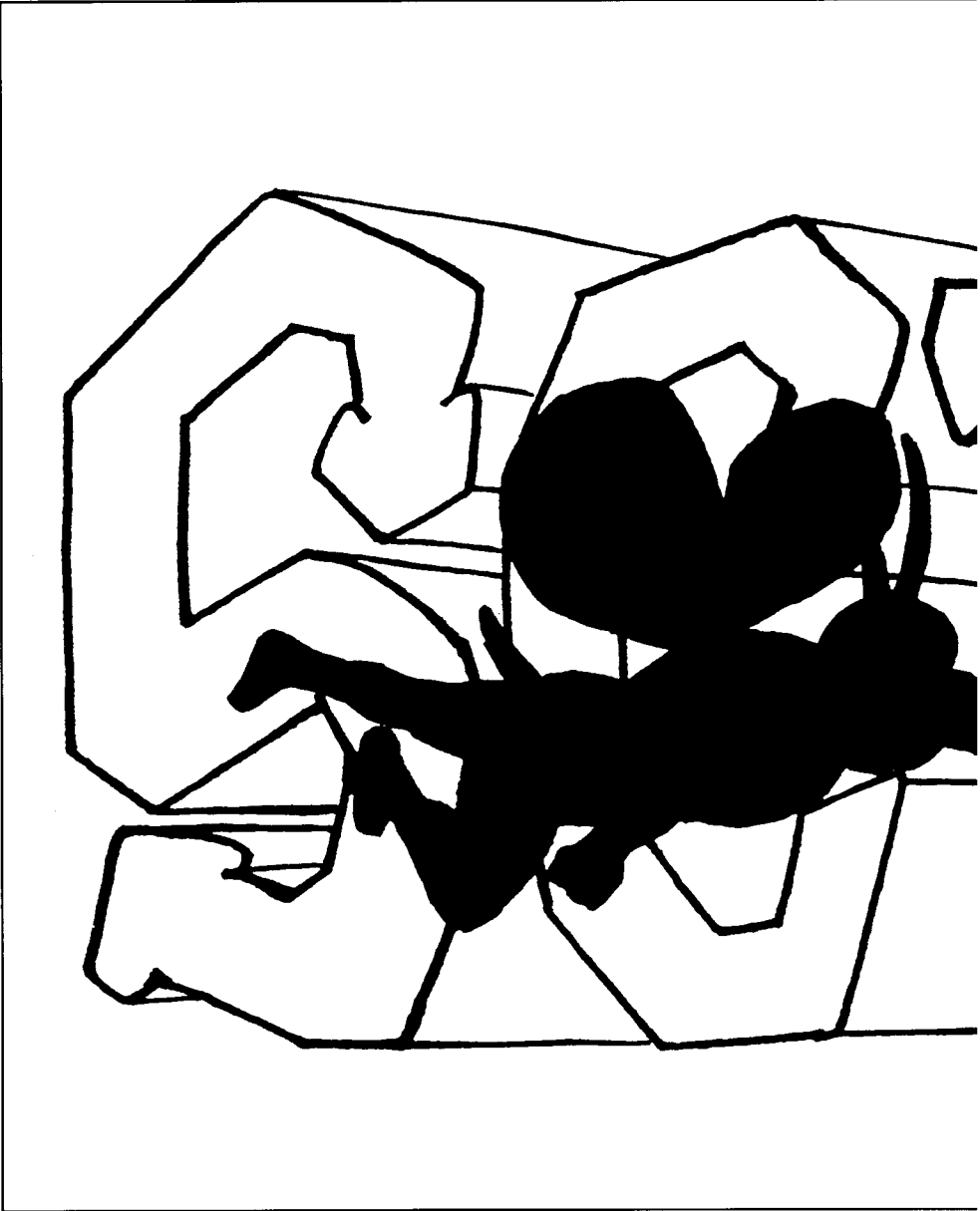

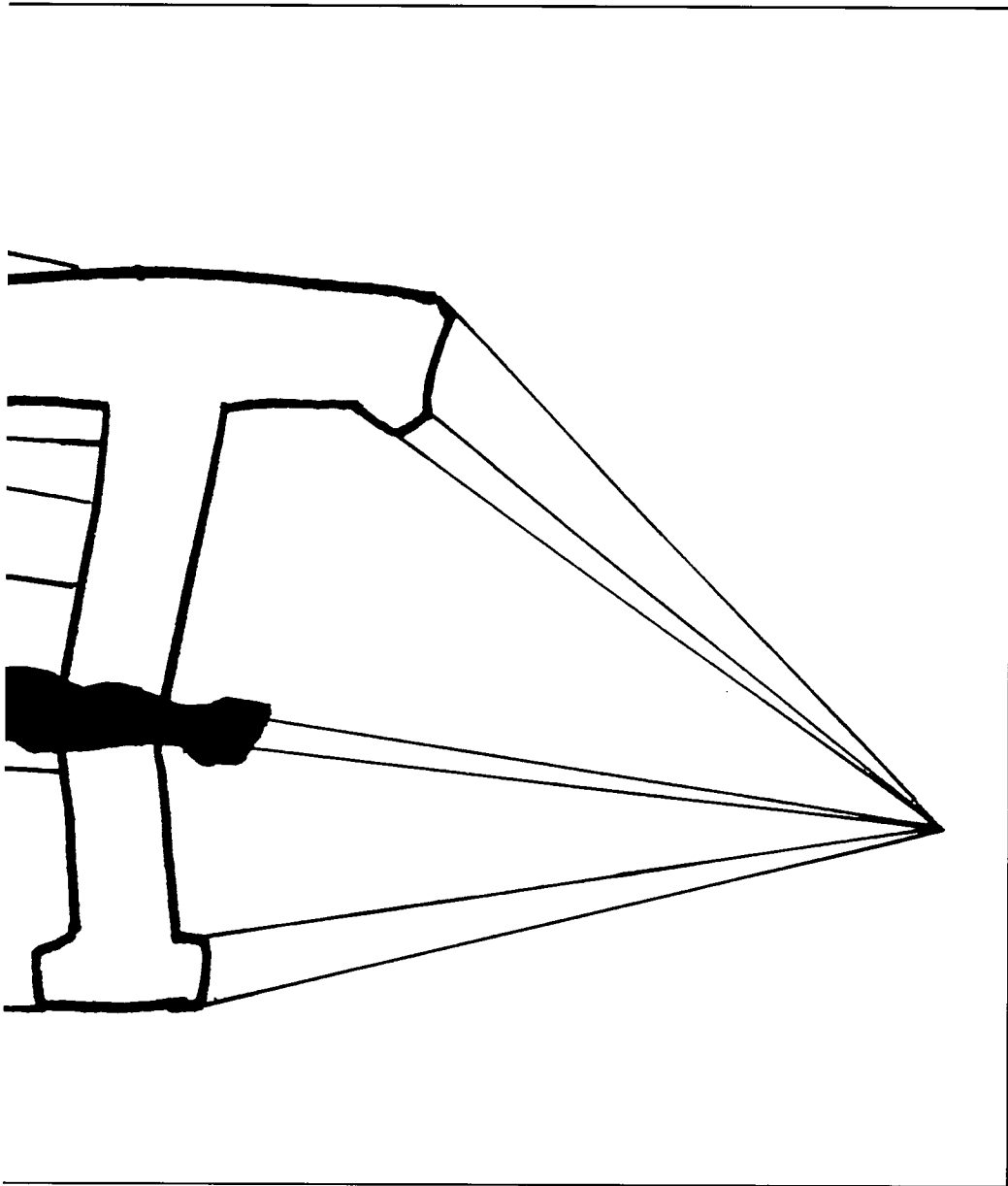

SOUTHERN TECH
PRESIDENT



STEPHEN CHESHER

VICE PRESIDENT FOR STUDENT AFFAIRS



CHARLES E. SMITH

VICE PRESIDENT FOR
BUSINESS & FINANCE



FAYE BARBER

V
I
C
E P
R
E
S
I
D
E
N
T F
O
R

A
C
A
D
E
M
I
C A
F
F
A
I
R
S



H
A
R
R
I
S T. T
R
A
V
I
S

E. A. VIZZINI, DEAN OF THE SCHOOL OF ARTS & SCIENCES

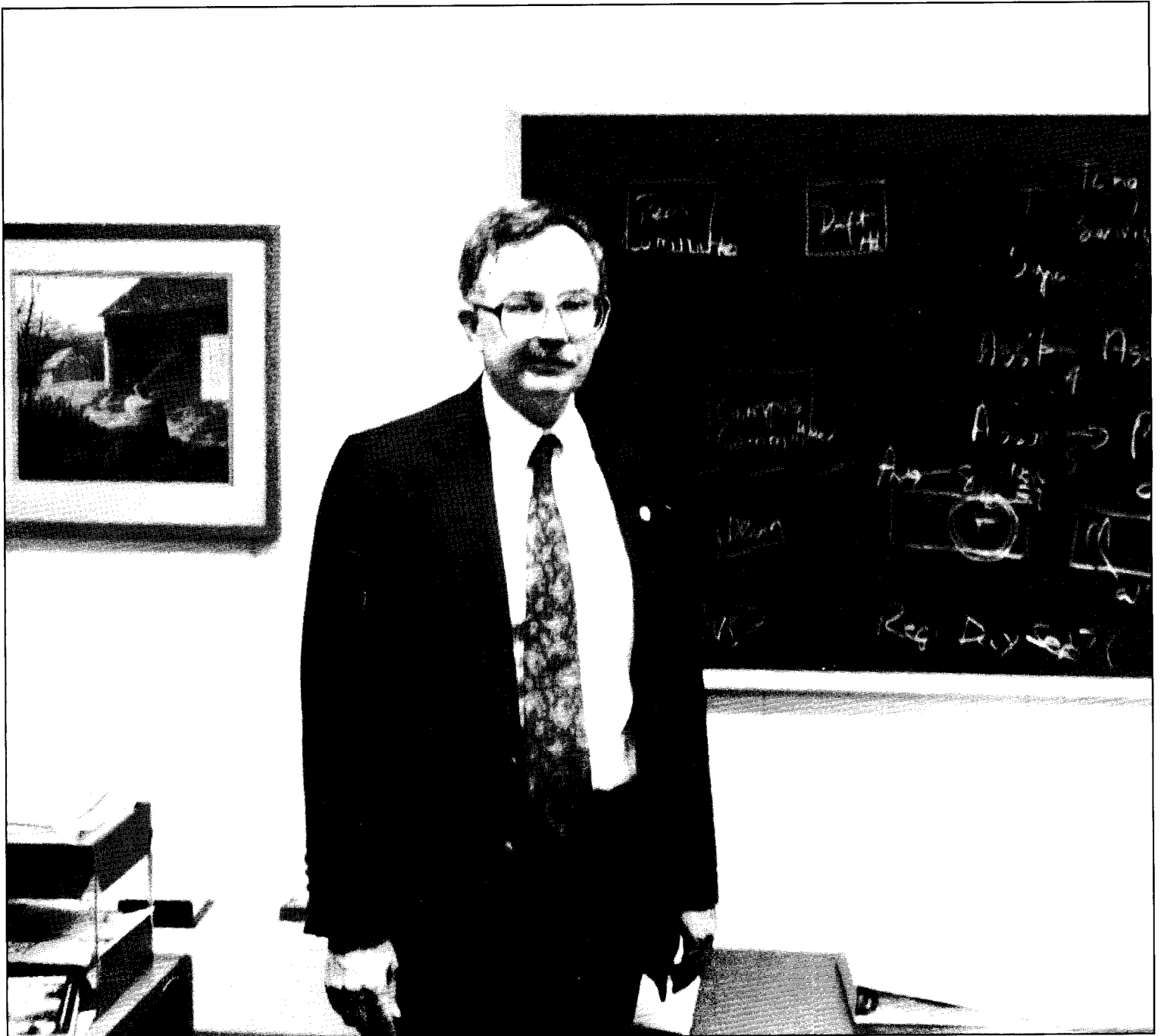

ROBERT J. YANCY, DEAN OF THE SCHOOL OF MANAGEMENT



CIVIL ENGINEERING TECHNOLOGY



Department Head: Tate, Boyce D
Secretary: Patel, Sarah
Allen, Harry D
Beadles, Sam
Crim, Richard D
Currin, Thomas R

Hornbeck, David E
McGowan, Kathleen C
Northcutt, Maurice L
Orlandella, Michael R
Pherson, Patrick
Troemel, Hans A

COMPUTER SCIENCE

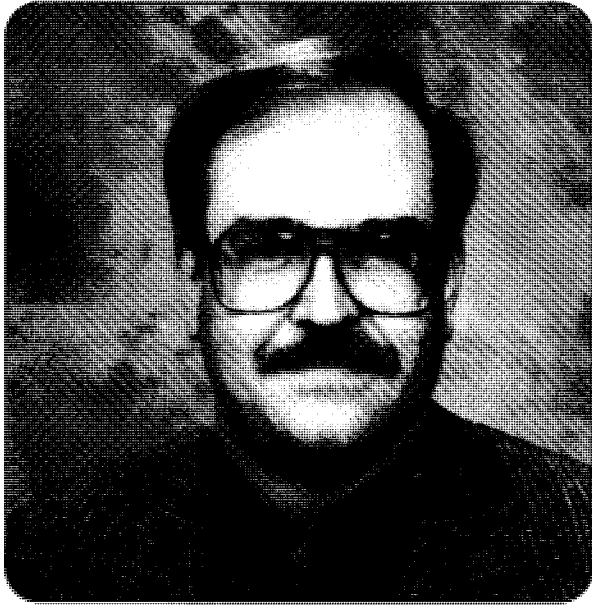

Department Head: Murphy, Michael G



Thomas, Barbara B

Secretary: St. Cyr, Shirley
Duggins, Sherl L
Eure, Bruce T
Harwell, Amy M

McPherson, Janice
Pournghshband, H
Rutherford, Rebecca
Sage, Sally A
Schroeder, Ronald N
Trahan, Chester T

Hartfield, Fred D



Harbort, Robert A



ELECTRICAL AND COMPUTER ENGINEERING TECHNOLOGY

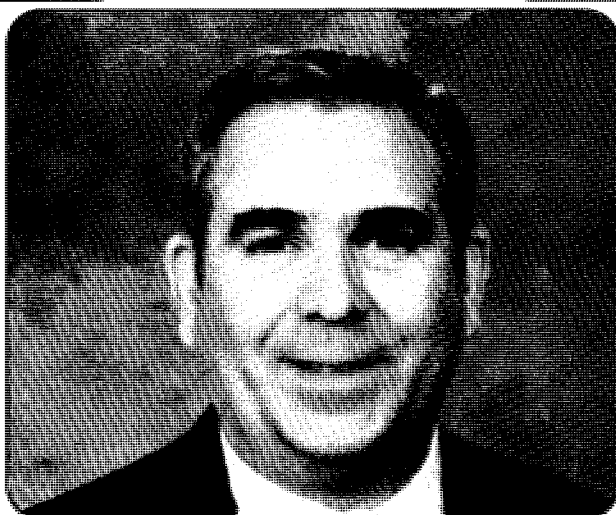
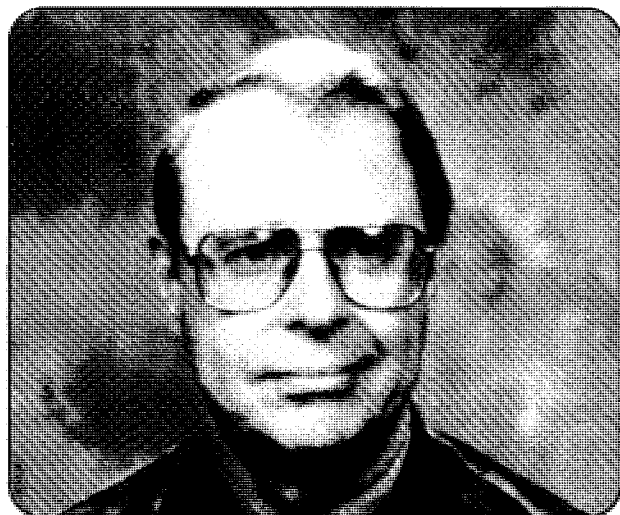
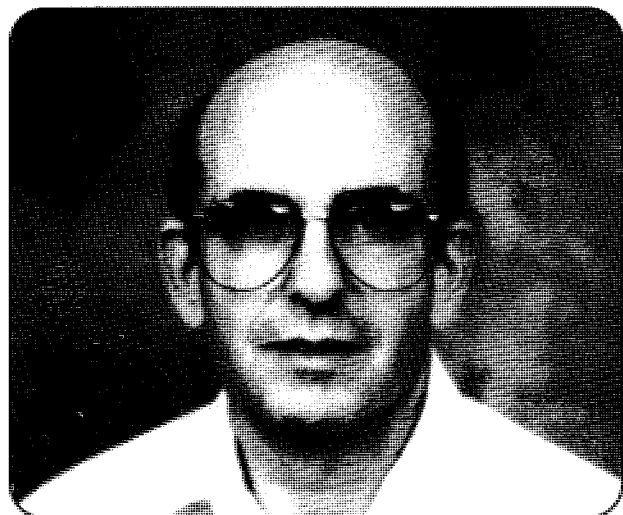

Department Head: Wilson, Julian A

Secretary: Cook, Alberta

Bachman, Charles L

Cail, Lawrence

Castellucis, R L

Colt, Jon C

Dreyer, Robert N

Frinzi, Pamela S

Hodges, William R

Kent, A Leo

Lewis, Linda L

Noneaker, Daniel O

O'Shea, Richard P

Robinson, Robert W

Rupf, John A

Shults, Roy L

Summers, David E

Taylor, Katherine P

Trent, Edward B, Jr

White, Preston A

Wojnowiak, Paul

Zadnik, Vickie L

Zia, Omar

Zimny, David W

HUMANITIES & COMMUNICATIONS

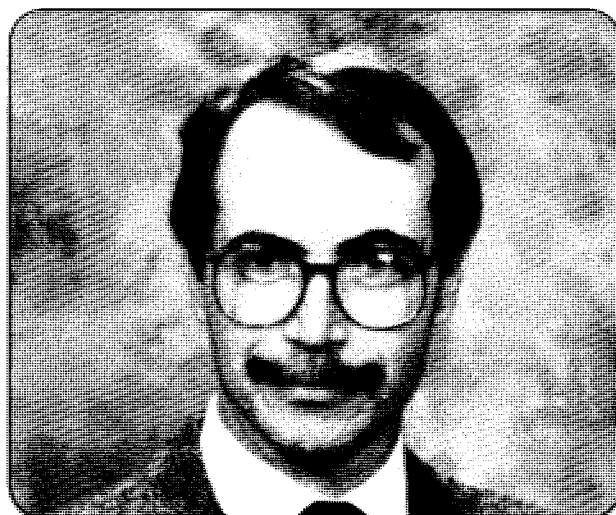

Department Head: Pfeiffer, William S
Secretary: Trepke, Jerri M
Barnum, Carol M
DeRocher, Cecile A
Kelly, Rebecca
McCoy, Joan D
Morrow, Susan R
Pevey, Jo L

Rainey, Kenneth
Seabolt, Betty O
Smith, Herb J
Stevens, Mark K
Thomas, Welyne N
Tumlin, John S
Wess, Robert C
Wiseman, Thomas L

INDUSTRIAL ENGINEERING TECHNOLOGY



Department head: Carmichael, Thomas H
Secretary: Brooks, Judith A
Aft, Lawrence S
Atkins, Robert W
Brooks, Glenn E
Caudill, David F
Cook, Lori S

Dollar, Edward L
Franklin, Patricia A
Hamrick, J L
Kling, James H
Kriner, Geraldine M
McKee, Jaames E
Stephens, Kenneth S
Wimberly, Charles A

MATHEMATICS

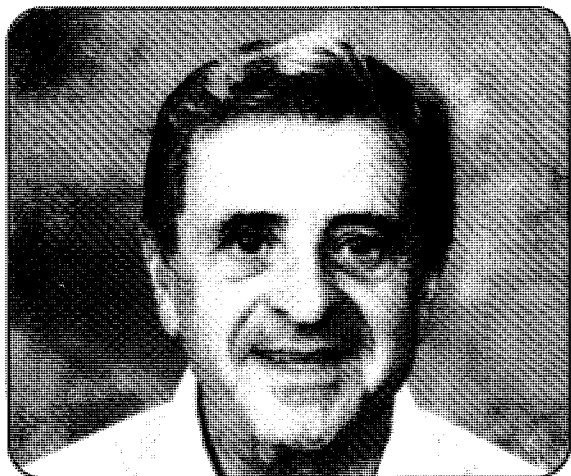

Department Head: Stricklen, Simon A
Secretary: Longshore, Jan
Abu Said, Ahmad M
Deng, Shangrong
Dillon, Meighan I
Edwards, Steven R
Fadyn, Joseph N
Flannery, Barry R
Fowler, Joel



Hall, Kathleen A
Kropa, James C
McMorran, Andrew G
Pace, Jack R
Vinelli, jose
Wiener, Sanford M
Young, Donald F
Ziegler, John A

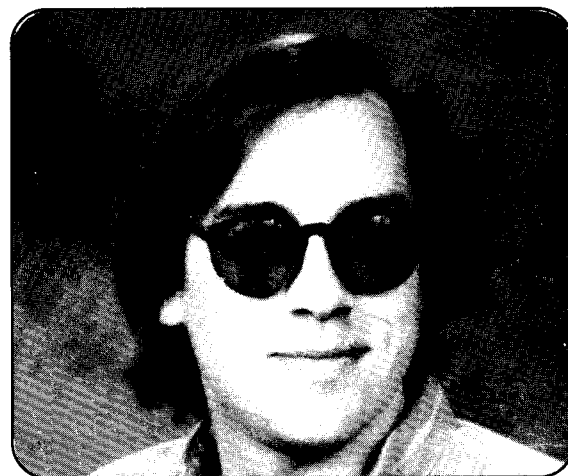

PHYSICS AND CHEMISTRY

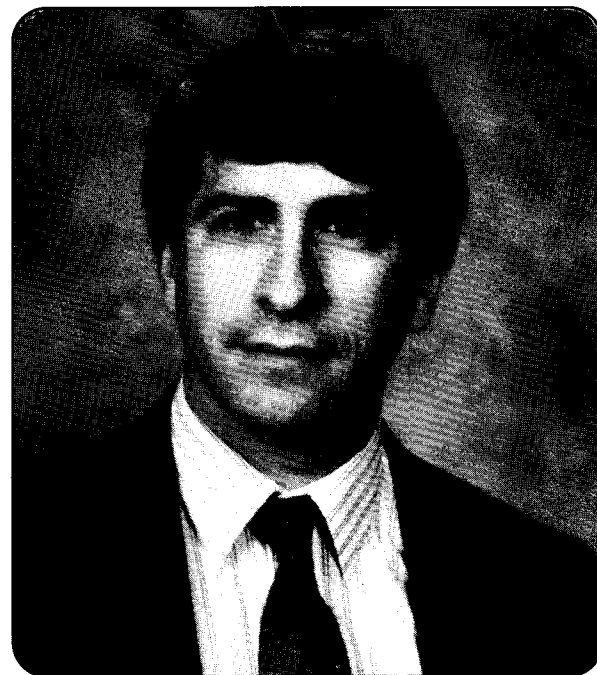
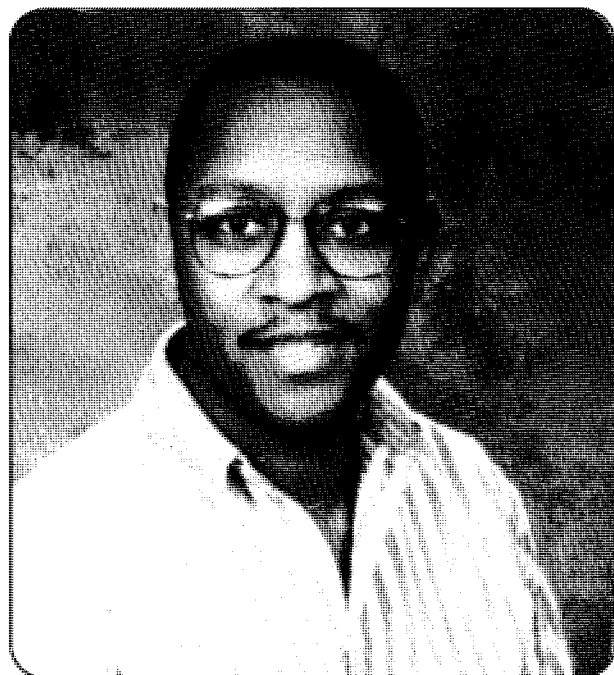

Department head: Scales, Sam A
Secretary: Tanner, Carolyn G
Gabrielli, Alan M
Lahiri, Jayanti
Oxford, Earl T
Patrick, Russell
Patterson, Philip E

Robinson, George W
Tambe, Balkrishna R
Thackston, Michael G
Tippens, Paul E
Tucker, Lee M
Whitenton, James B
Wrege, Julia B

SOCIAL & INTERNATIONAL STUDIES



Acting Department Head: Fischer, Robert J
Secretary: Stanford, Debbie J
Bennett, Richard A
Cochrane, Jacquelyn L

Newell, Julie R
Nuhfer-Halten, Bernice
Weeks, Charles J

TECHNICAL MANAGEMENT

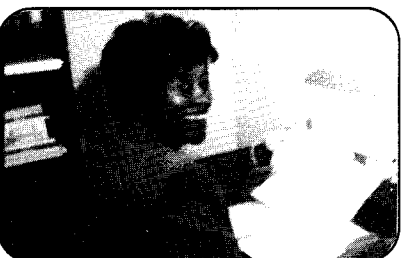
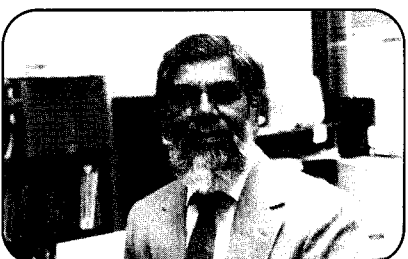
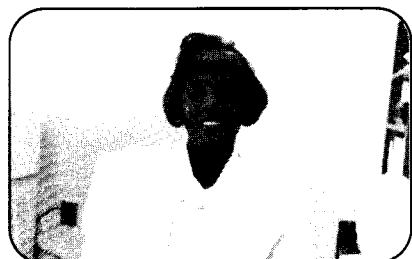

Department Head: Yancy, Robert J
Secretary: Dees, Terressa Darlene
Compton, Ruth H
Davis, Sidney
Hudson, Veronica

Lucas, Terry L
Obeidat, Mahammed A
Vasa-Sideris, Sandra
Warsi, T A

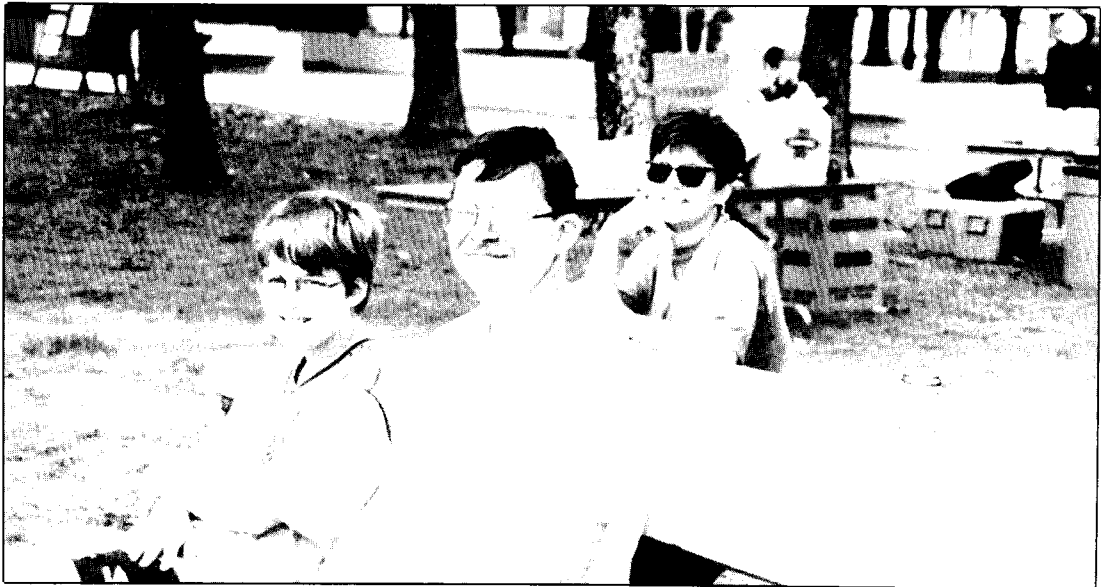
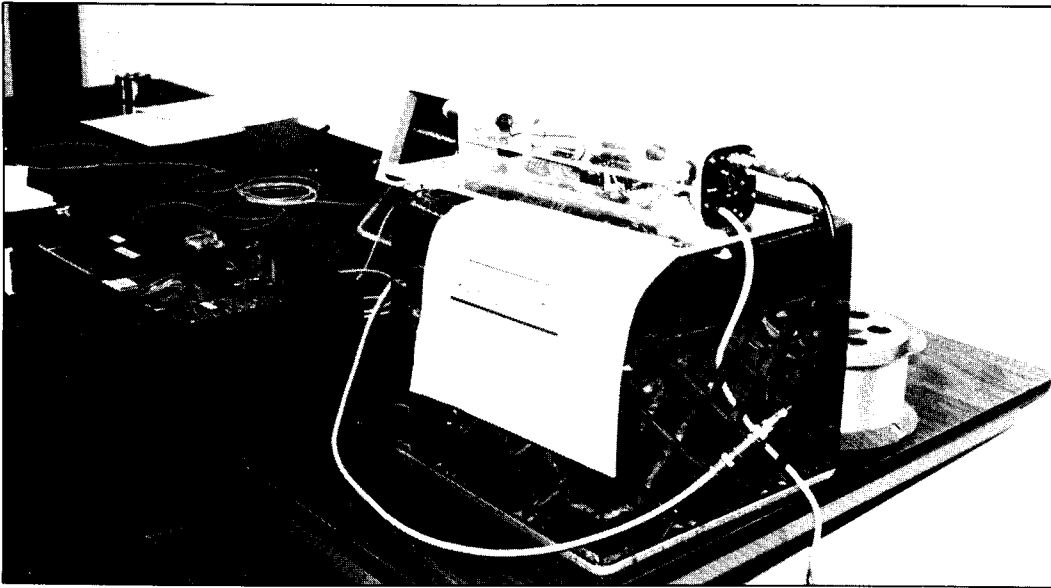

SPORTS

BASKETBALL
BASEBALL
TENNIS

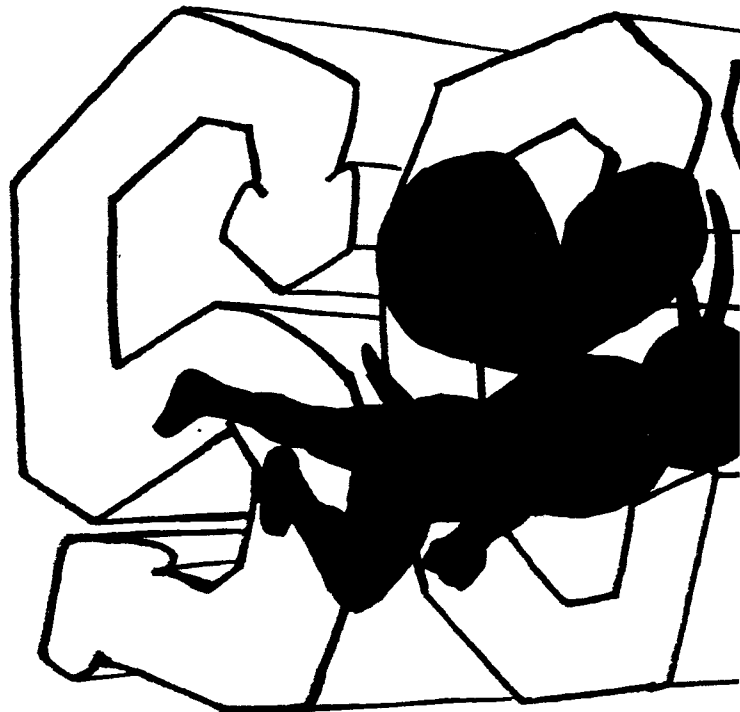

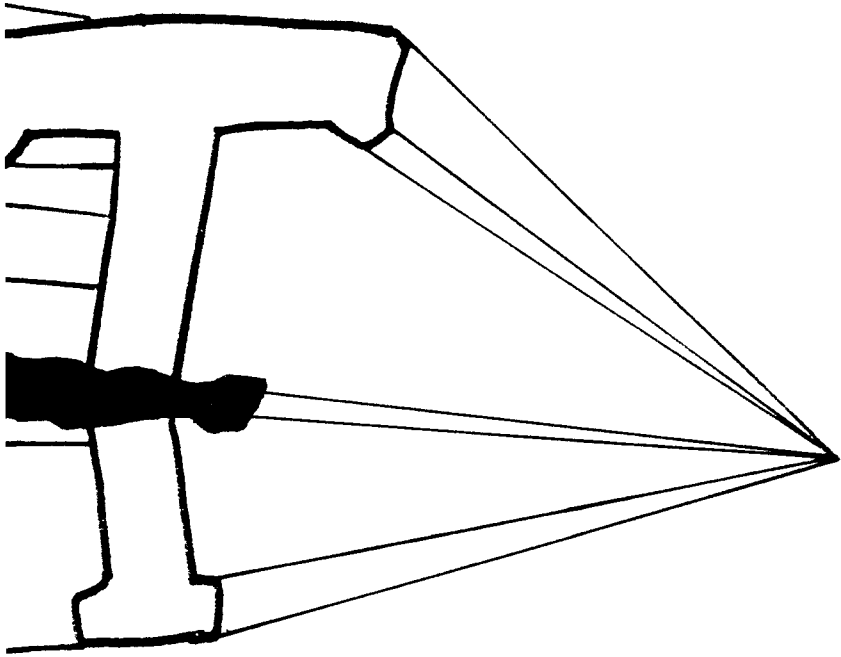

BASKETBALL

The Hornet Basketball team enjoyed great success in the 1993-1994 campaign once again making it to the second round of the playoffs and for the first time in the history of the rivalry defeating Life College 70-63.

The Hornets led off the season with a resounding 93-39 victory versus Allen University to start off the home season. After losing on the road to Montevallo University 50-62, the Hornets returned home and defeated Allen University by the score of 72-51 and won the seasons second meeting against Montevallo 77-54. The Hornets took the opener in the Hornet Classic against Nova 72-65 and lost in the championship game by the heartbreaking score of 71-72.

The Hornets hit a bit of a rough spot losing three of their next four games. The Hornets lost to Tennessee Temple by a score of 57-66. Next the Hornets were defeated by Kennesaw State 46-52, and Selma in the second round of the Faulkner Invitational to end the month of November, but they picked up the pace in December defeating Tennessee Temple 79-55, Selma University 65-46, Tennessee Wesleyan 81-56 and North Georgia College 52-45 to give the Hornets their first Conference win of the season.

The Conference schedule was brutal in the Hornets new district. Southern Tech was defeated by Brewton-Parker 48-54 and Clayton State 51-66 before they earned their second conference win of the season against Berry College 68-65. The Hornets lost to LaGrange on the road 72-73 before defeating Shorter 78-63. Georgia Southwestern was next for the Hornets. The Hornets emerged victorious 77-70 before moving on to defeat Piedmont 75-63 before losing to North Georgia on the road 56-57.

Then the second game of the season versus Life came where the Hornets won for the first time ever in front of a very enthusiastic crowd 70-63. Following that victory the Hornets travelled to LaGrange winning by a score of 98-76. Brewton-Parker was next up for the Hornets. The Hornets handily defeated them 66-49. This put the Hornets at 7-4 in the conference just weeks away from the playoffs. The Hornets beat Piedmont 79-69 before returning home to face off against Clayton State in a losing cause 68-83.

A narrow victory against Shorter 55-53 upped the Hornets conference record to 9-5. Consecutive losses to Kennesaw 59-64 and Georgia Southwestern 51-63 slowed some of the momentum the Hornets had before winning their final regular season game over Berry 67-66. The Hornets finished the regular season with a respectable 19-13 record overall with a 10-6 record against conference opponents.

In the first round of the playoffs the Hornets defeated LaGrange 61-60. The Hornets season ended in the second round against GA Southwestern 62-78.

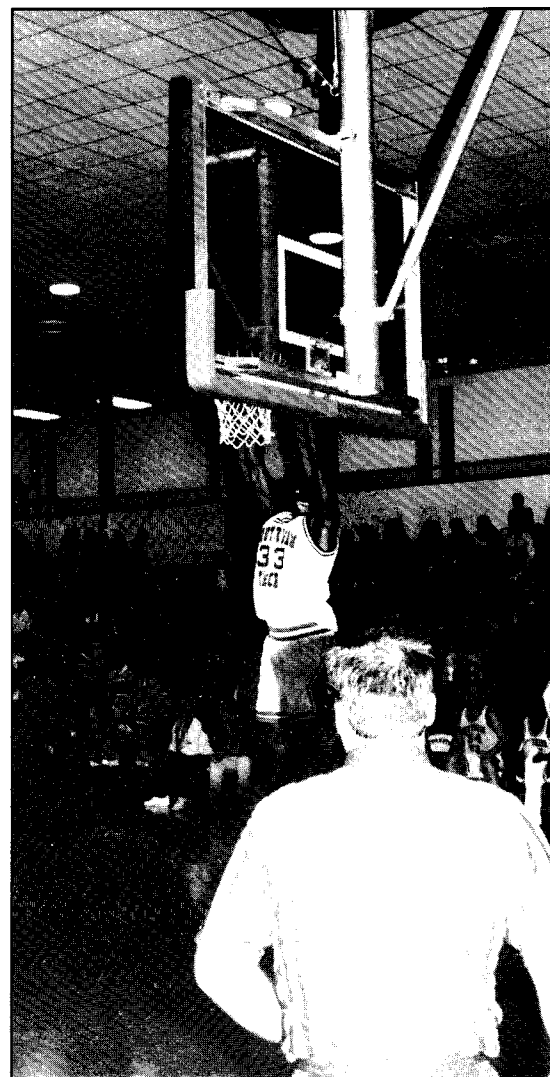

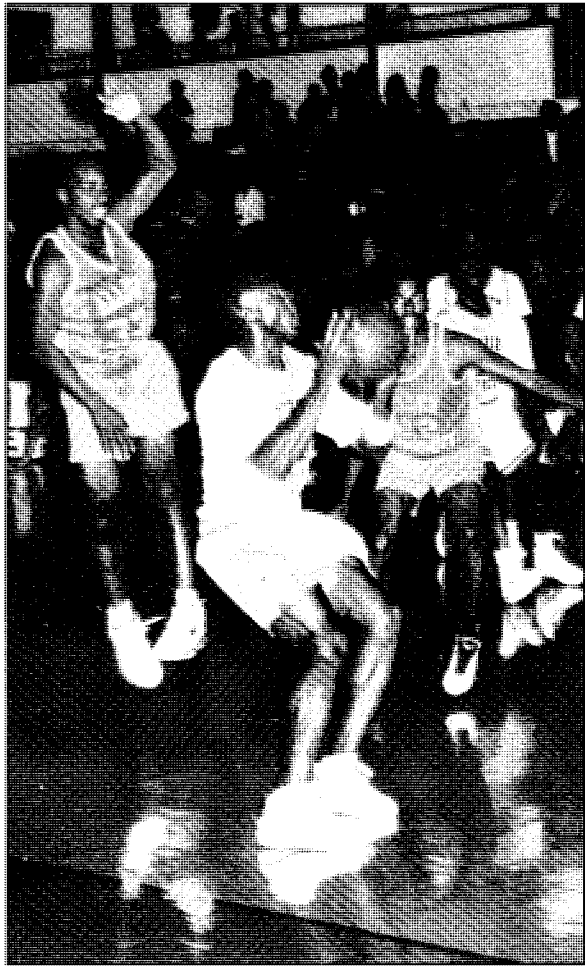

- 10-Willie Rodgers
- 11-Melvin Harty
- 12-Terry Herrod
- 13-Ronnie Brown
- 15-LeTread Waller
- 20-Jabar Dozier
- 25-Jermaine Griggs
- 33-Ricardo Pierre
- 35-Henry Wright
- 40-Maurice Holifield
- 51-Michael Morgan
- 54-Clay Davis

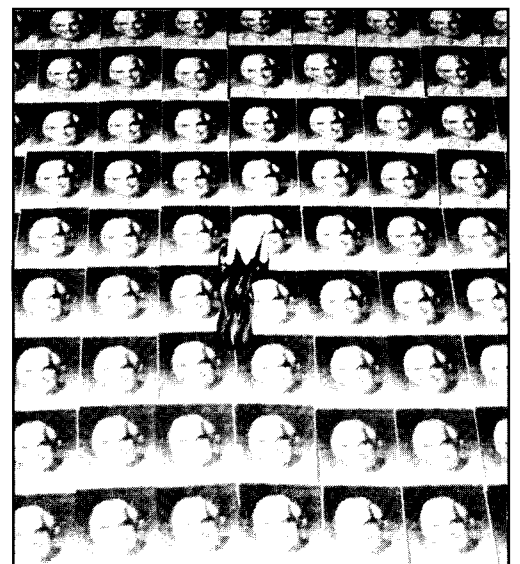

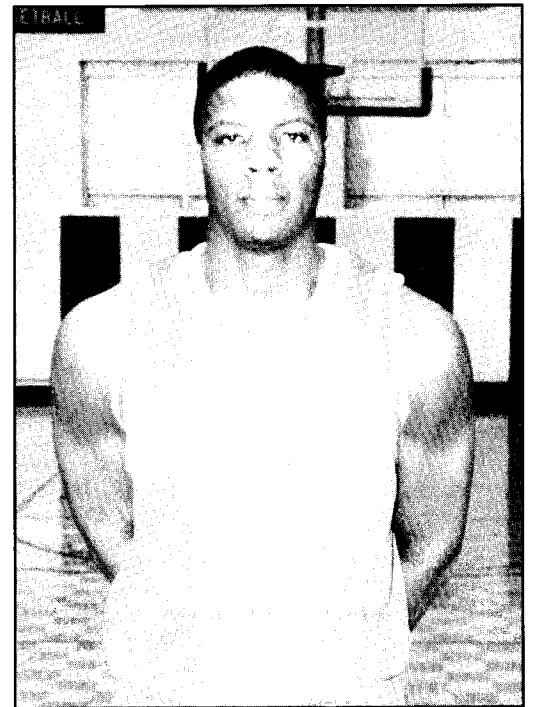
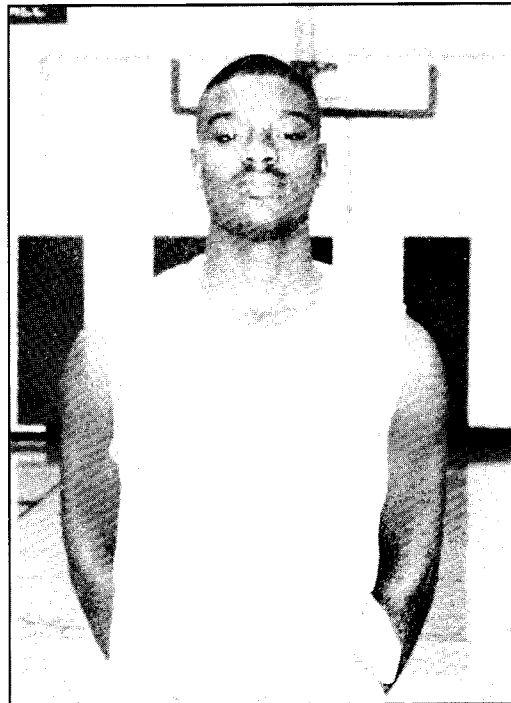
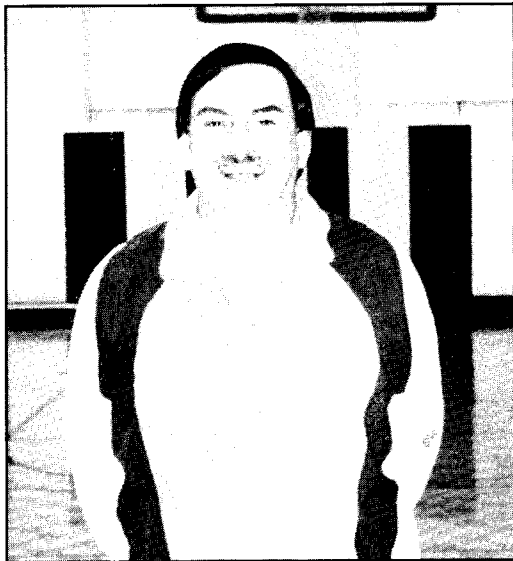
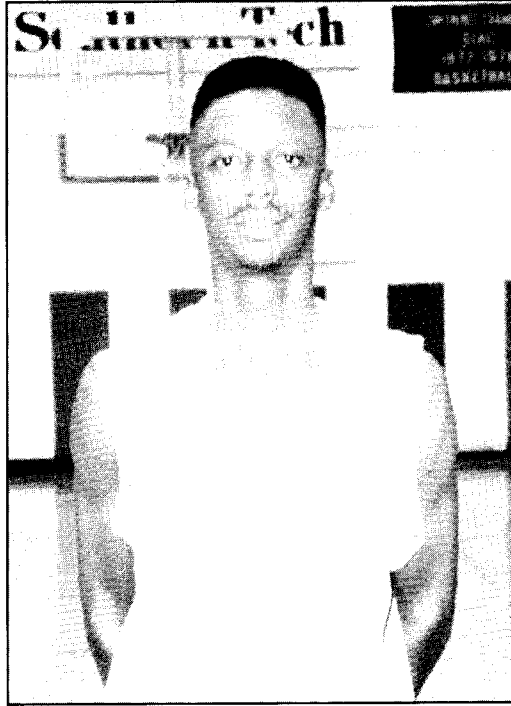
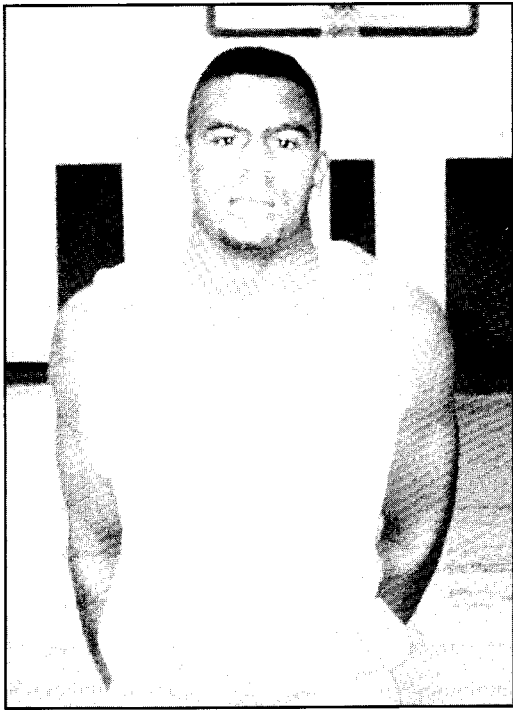

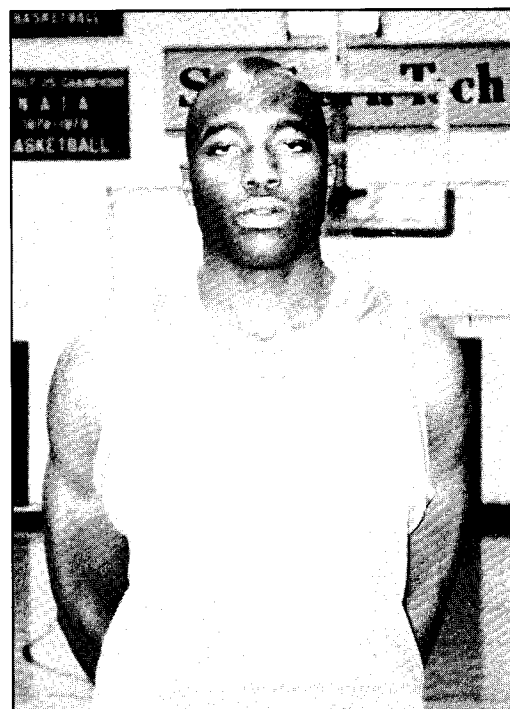
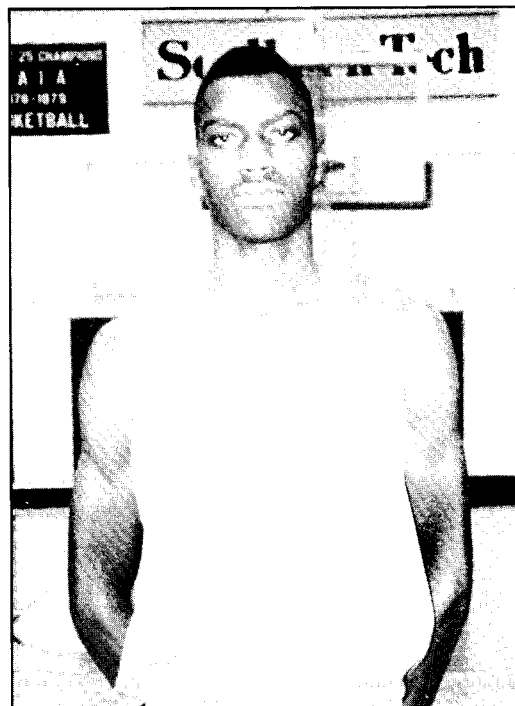
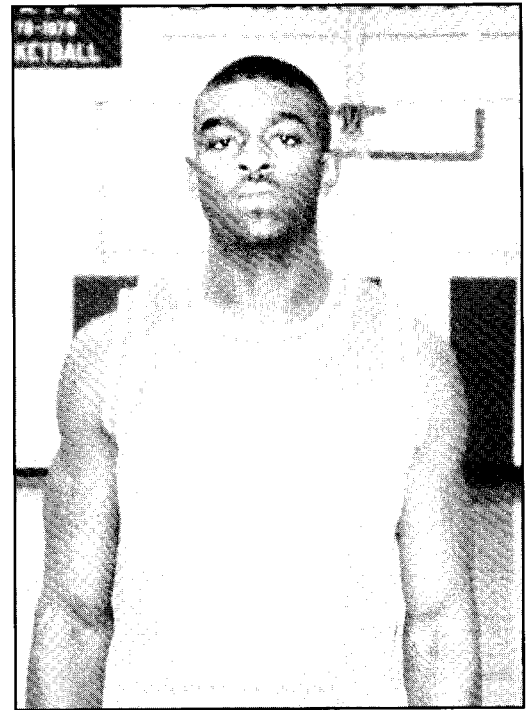
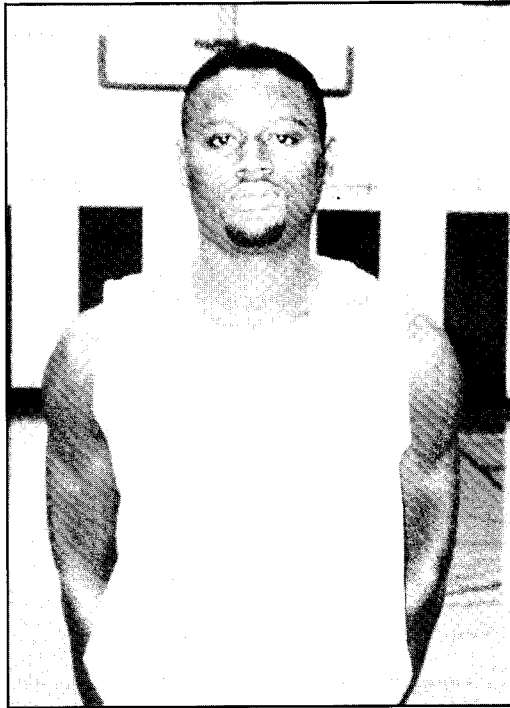
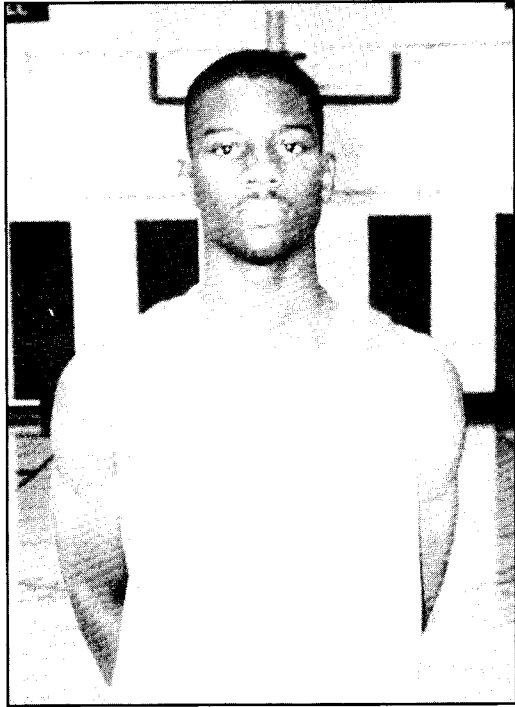

BASEBALL

Outfielders

13-Morris Bingham

23-Robert Bryant

12-David Carrol

27-Matt Compton

16-Aaron Griffin

28-Shane Lee

Infielders

17-Ben Bushong

15-Keith Goble

7-Mickey Harper

2-Lawrence Holmes

22-Roc Hughes

1-Juan Johnson

26-John Leach

33-Kevin Medlin

9-Greg Stewart

14-Jeromy Stroud

Catchers

25-Jeff Beagles

3-Mickey Eidson

5-Nathan Schroeder

Pitchers

18-Chris Cady

30-Jeff Cason

21-Martin Maldonado

29-Billy Miller

32-Eric Nicholson

11-Greg Shook

34-Danny Smith

19-Ken Wiggins

-Jeraine Lovejoy

Head Coach

20-Charlie Lumsden

Assistant Coach

24-Eric Alexander

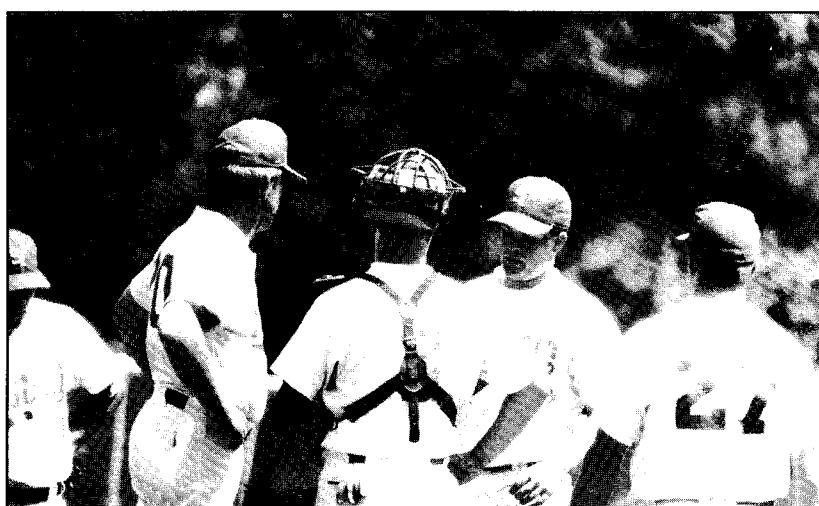
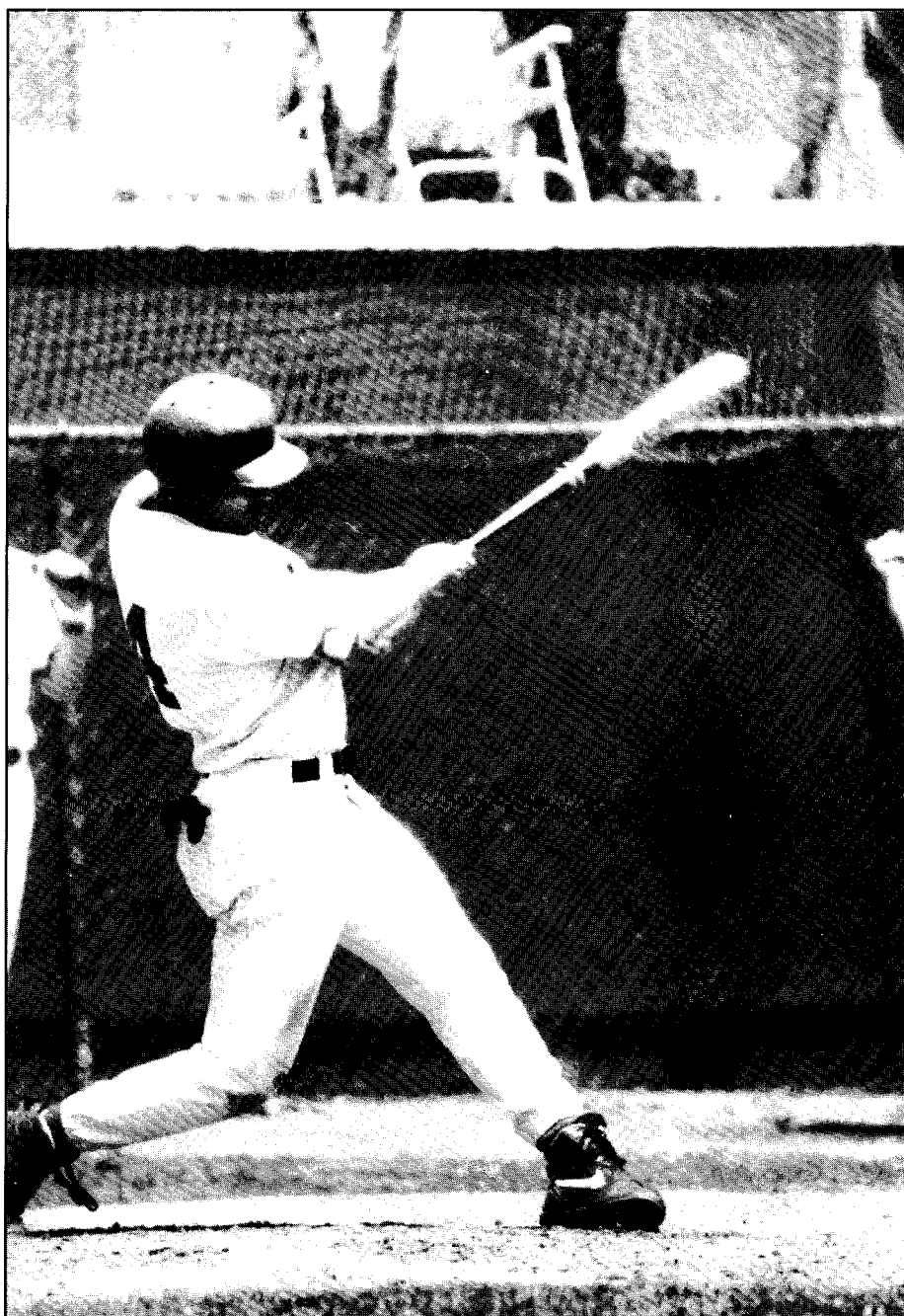

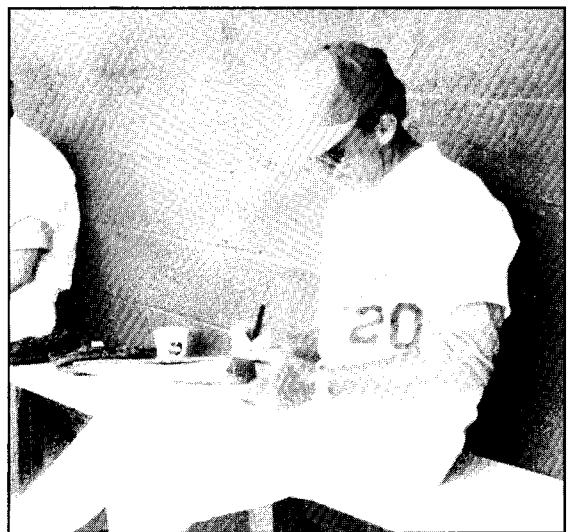
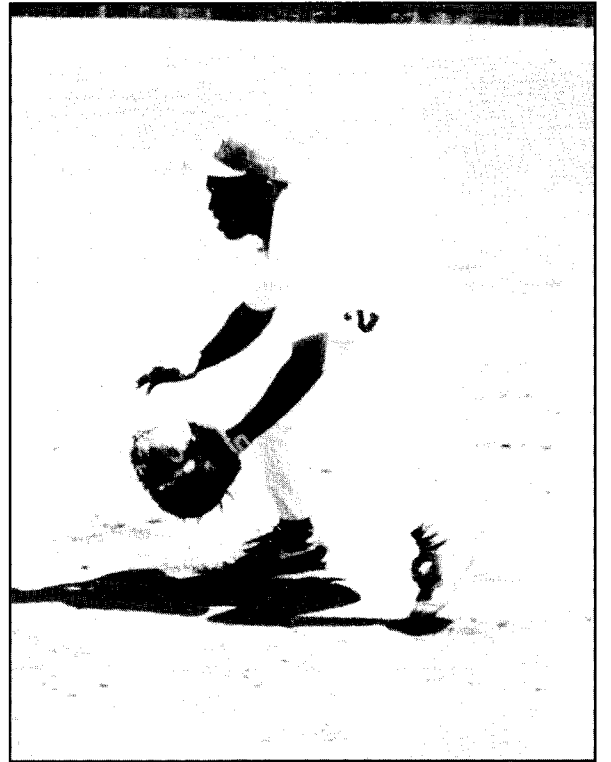

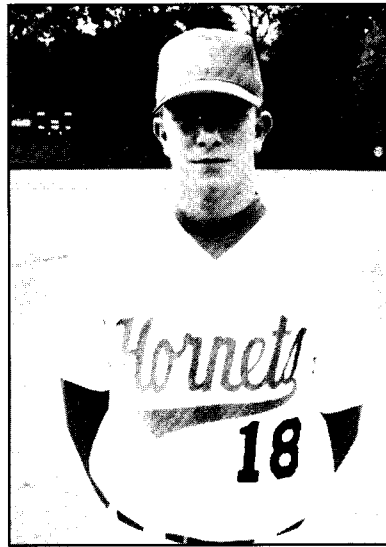
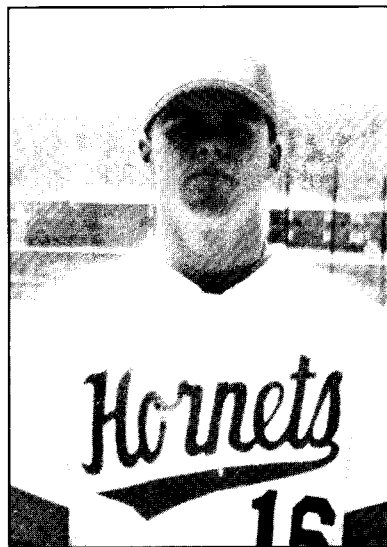
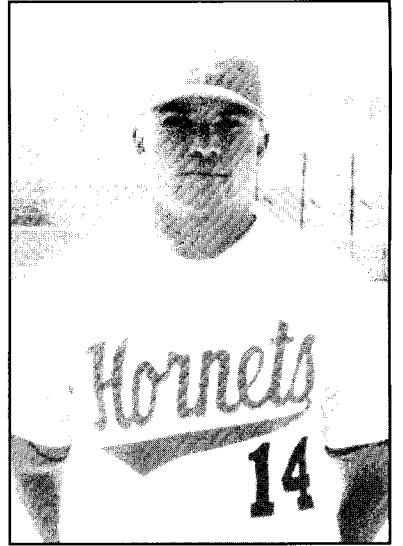
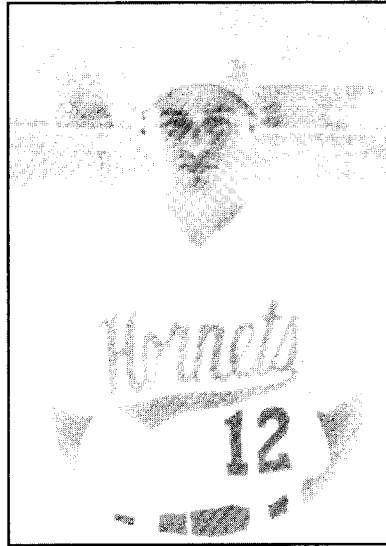
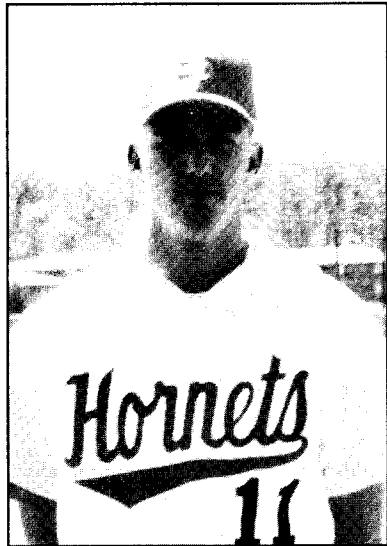
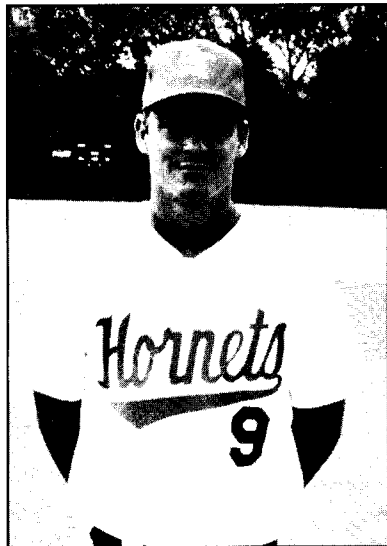
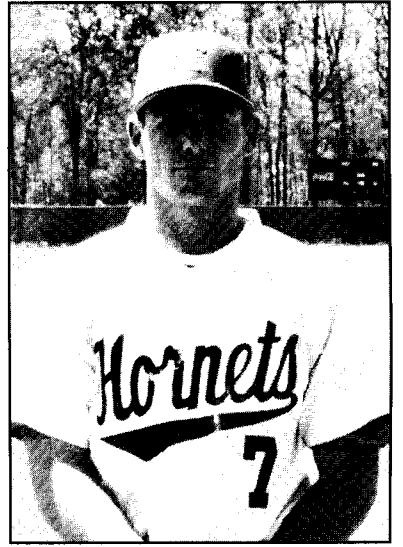
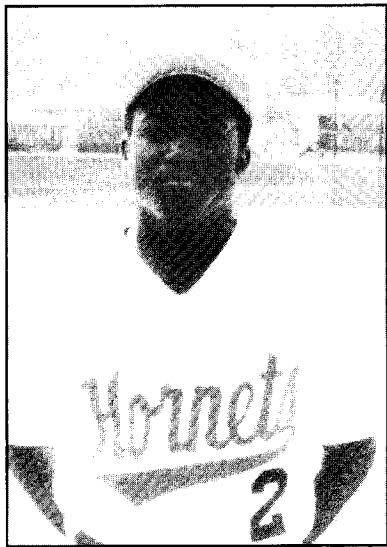

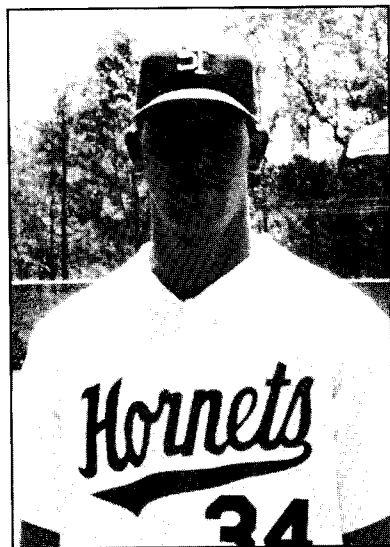
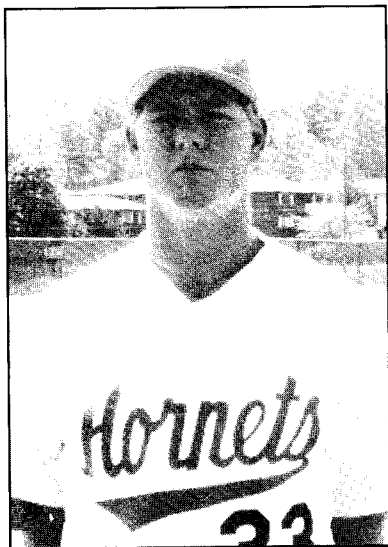
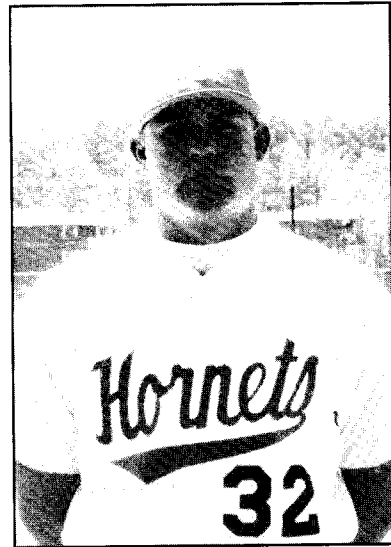
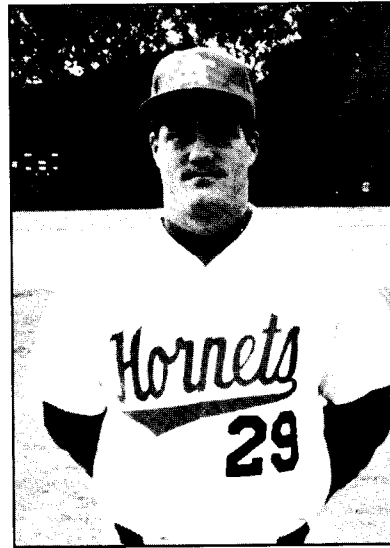
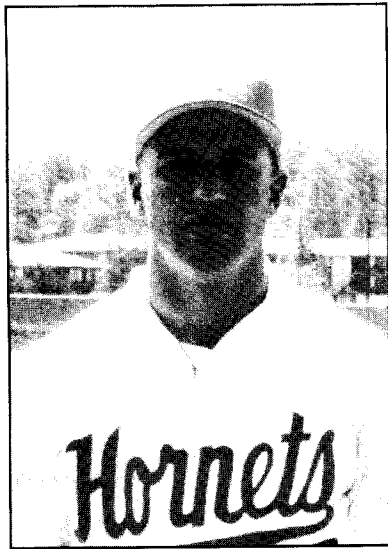
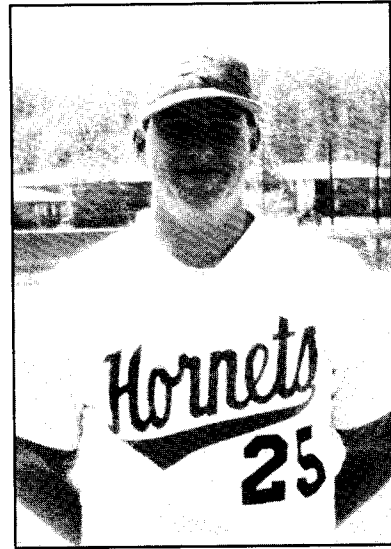
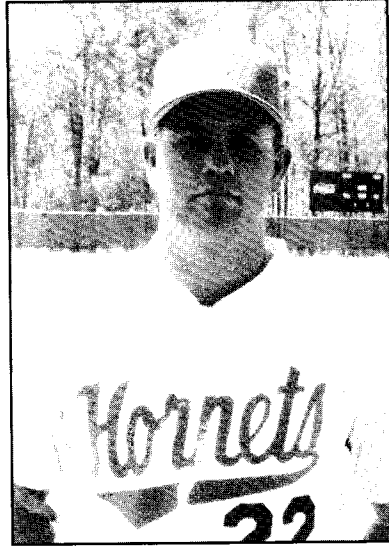

SOUTHERN TECH TENNIS



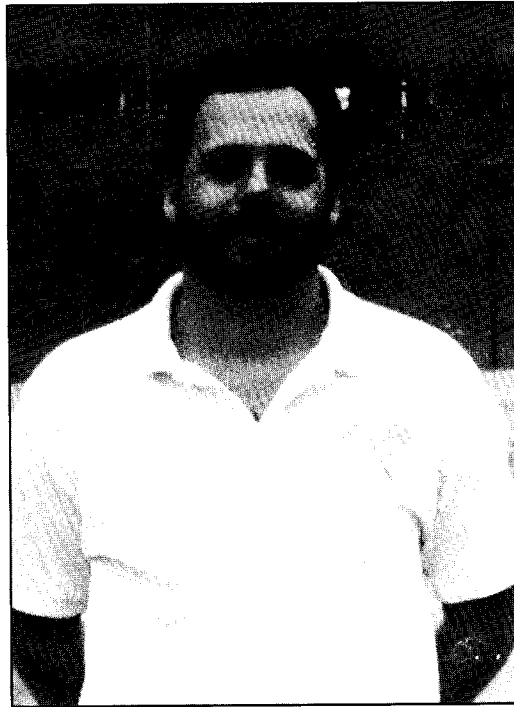
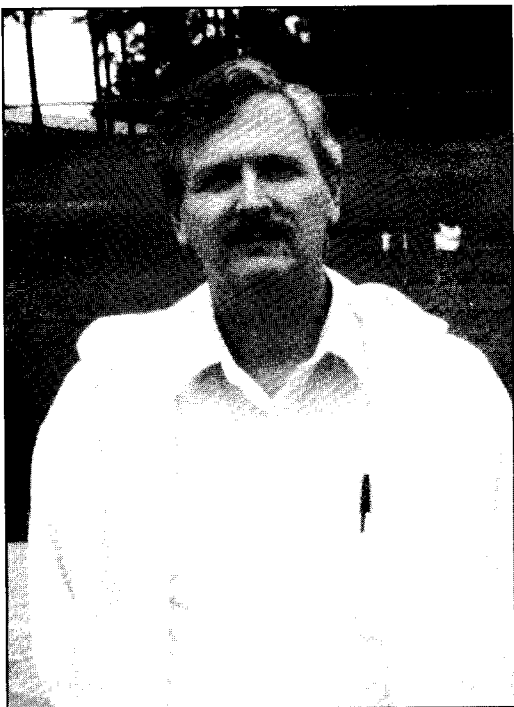
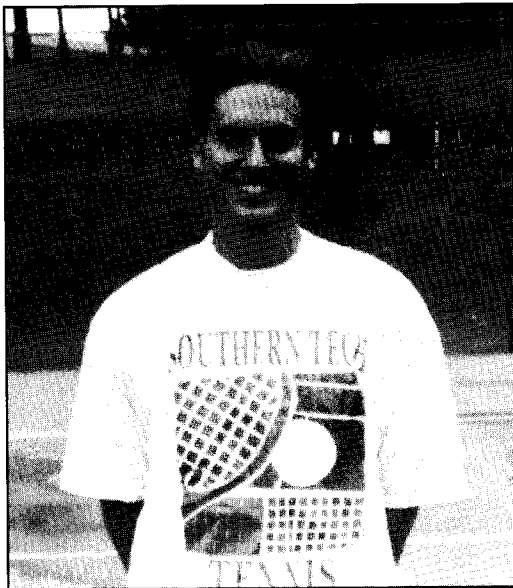
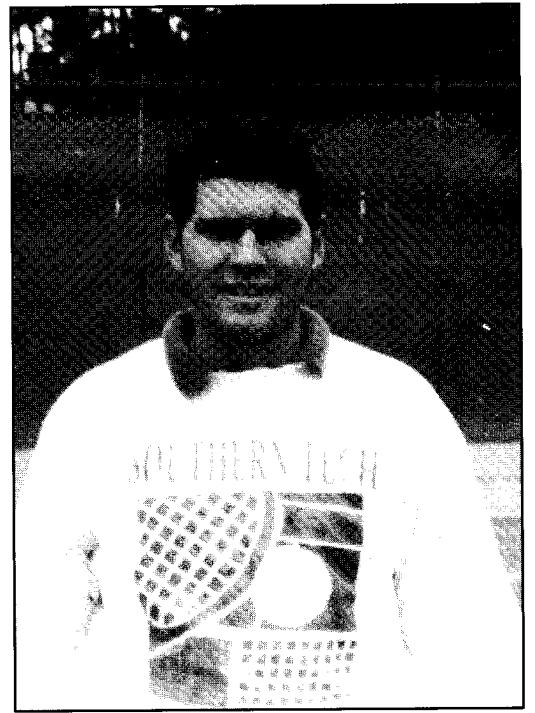
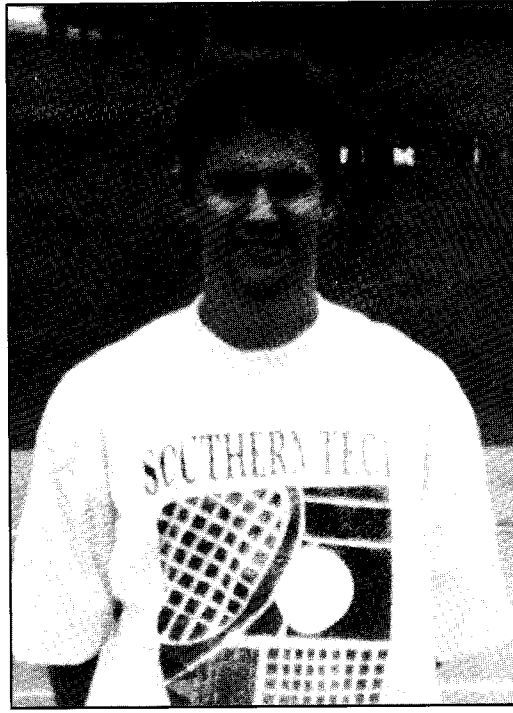

ORGANIZATIONS

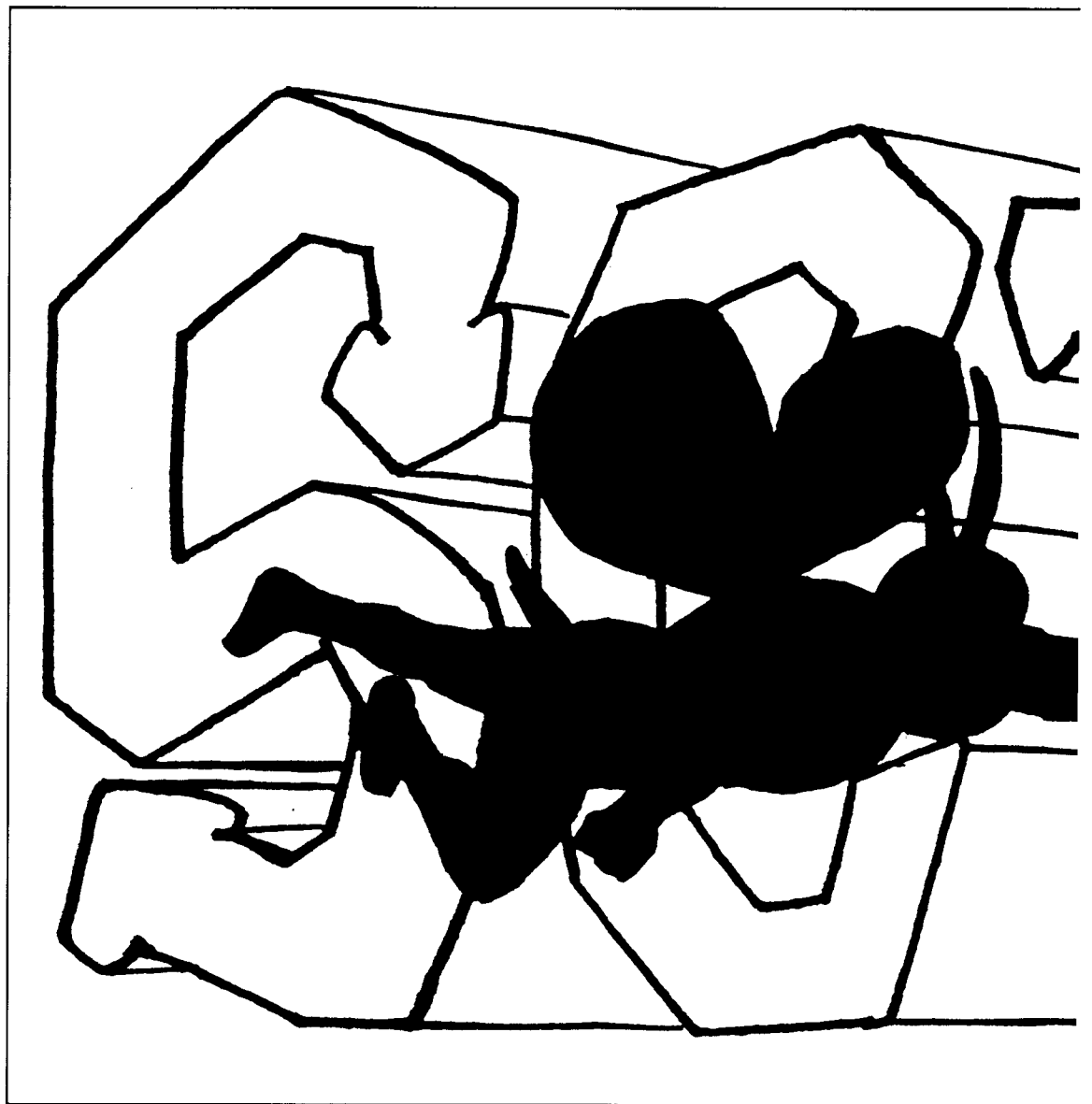

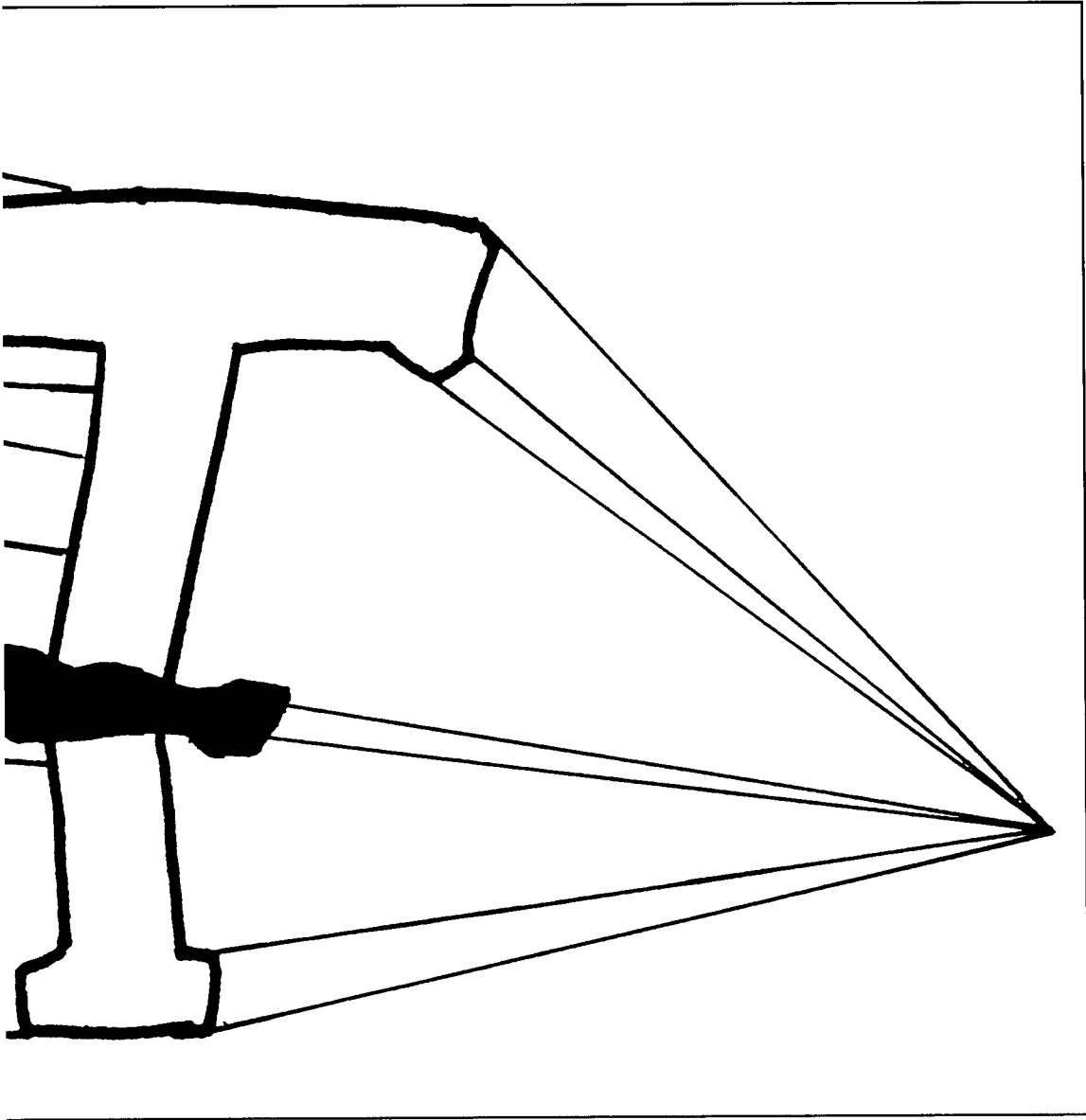

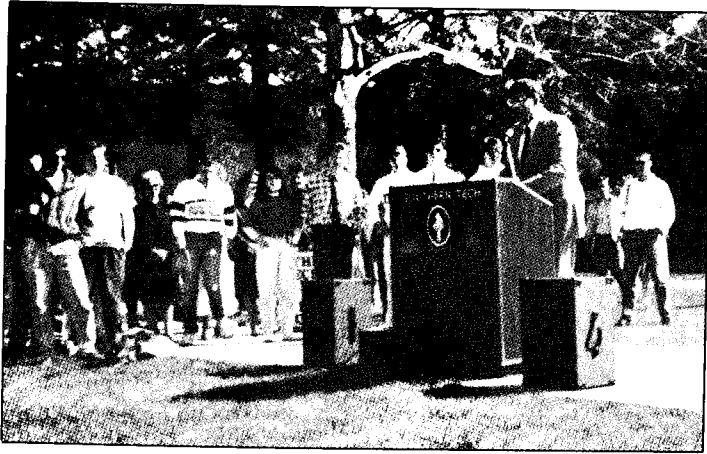



NATIONAL SOCIETY OF BLACK ENGINEERS

The National Society of Black Engineers with more than 9000 members and 155 chartered chapters was founded in April 1975 at Purdue University, and is one of the largest student run organizations in the country. The society is dedicated to the realization of a better tomorrow through the development of intensive programs for increasing recruitment, retention, and successful graduation of minorities in engineering. The objectives of the society are to:

- * Stimulate and develop student interest in the various engineering disciplines.
- * Strive to increase the number of minority students studying engineering at both undergraduate and graduate levels.
- * Encourage member to seek advanced degrees in engineering or related fields and to obtain professional engineering registrations.
- * Encourage and advise minority youths in their pursuit of an engineering career.
- * Promote public awareness of engineering and the opportunities for Blacks and other minorities in that profession.
- * Function as a representative body on issues and developments that effect the careers of Black engineers.

The NSBE torch symbolizes our everlasting burning desire to achieve success in this competitive society and to effect a positive change in the quality of life for all people. The lightning bolts represent the striking impact that is felt by the nation and industry due to the contributions of dedicated NSBE members.

Southern Tech's Chapter (STSBE) was born in the winter quarter of 1987. The 1993-1994 Executive board adopted the theme "Am I My Brother's Keeper." STSBE rented an office in the student center and produced its own newsletter "My Brother's Keeper" on a monthly basis. Activities included a corporate social, church visits, regional conferences, member ceremony, Black heritage celebration, co-host of career fair, PCI programs and various social events. The 1993-1994 Executive Board were:

- * Alejandro Ferrell, President
- * Albert Tino Shelby, Vice-President
- * Charmaine McKinney, Secretary
- * Marcia Griggs, Treasurer
- * Kimberly Battie, Charter/Membership
- * Thomas Rucker, Special Events
- * Andre' Willis, Public Relations/Publications
- * Robin Wagstaff, Academic Excellence
- * Janet Thompson, Fundraising
- * Troy Crafter, Pre-College Initiative

The advisors were Fred Hartfield, Veronica Hudson, and Phill Patterson.



Spring Regional Conference



Pre-College Initiative, Park Street Elementary

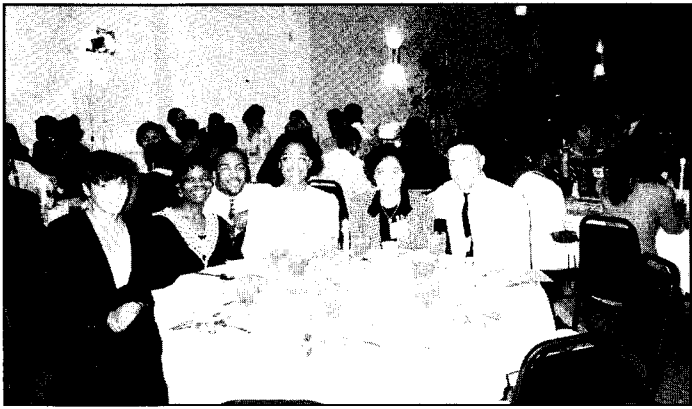

Fall Regional Conference



NSBE Dating Game

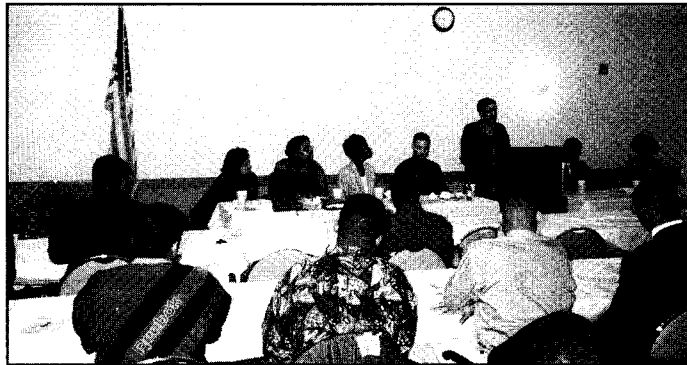

Member Ceremony



Just Chillin



Member Ceremony



A Few NSBE Members

LAMBDA CHI ALPHA

The brothers of Lambda Chi Alpha take pride in being the Fraternity of Honest Friendship. This past year, the brothers of the Sigma Xi Zeta made "the worlds largest rocking chair" for a Rock-A-Thon to support the Shriner's Burn Center. Lambda Chi Alpha teaches young men the principles of leadership, how to manage their college experience to its fullest potential, and provides great opportunity to create great memories. Lambda Chi Alpha takes great pride in building tomorrow's leaders today. The leaders this past year were:

President - John Newberry
Vice President - Billy Nix
Secretary - Tim Glover
Treasurer - Geoffery Sease
Risk Management - Jason McRae
Fraternity Educator - Jonathan Wang
Rush Chairman - Jeremy Shiftlett / Doug Ralston
Ritualist - Alan Rountree / John McDaniel
Educational Chairman - Kevin Leftwich
Alumni Secretary - Marty Purser
Chancellor - Tom Monroe
Faculty Advisor - Bud Northcut



First Rock-A-Thon for the Shriner's Burn Center



Good Food - Good Time - Great Fraternity!

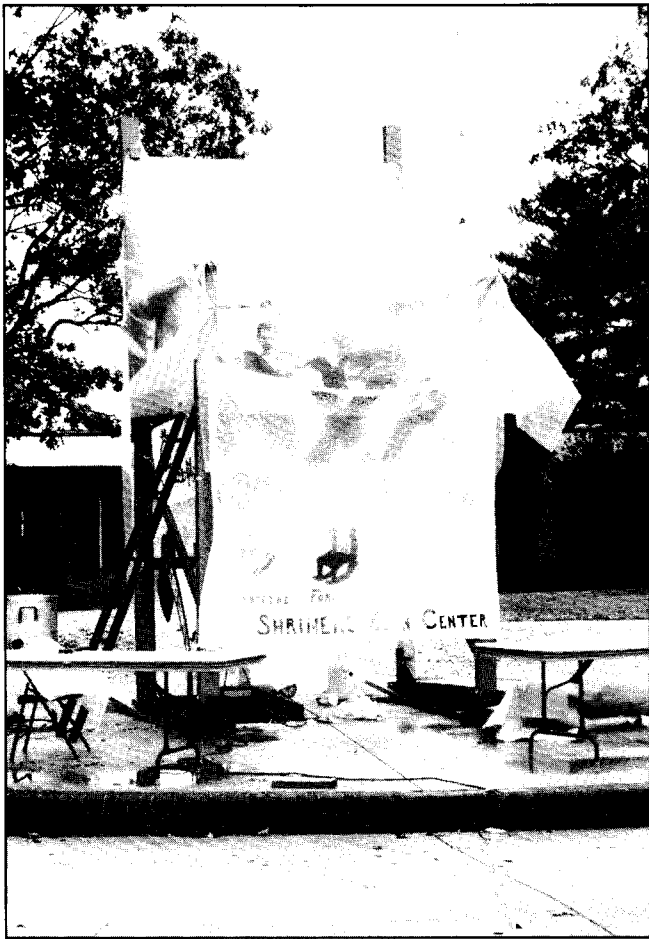

Rock-A-Thon Rain or Shine!



Lambda Chi makes me want to SHOUT!

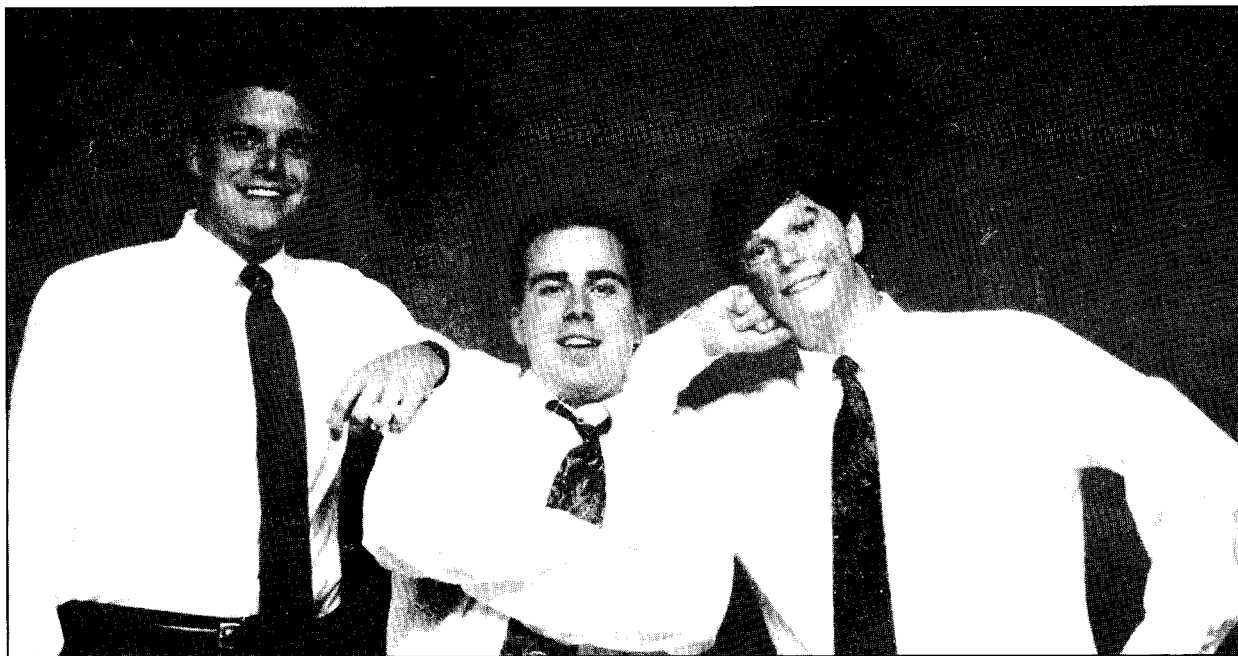

John, Geoff, Doug just hanging out

GAMMA PHI BETA

Everyone is aware of the fun and games we share together as Gamma Phi Beta sisters, but less often the serious side of college and sorority life is noticed. To us sisters, Gamma Phi Beta is a mutual bond sparked by the excitement of growing up, friendship, education, and love. Throughout the year, we extend our invitation to those who wish to become part of the ever growing sisterhood of Gamma Phi Beta.

Our year begins with Fall Rush where we hope to encourage others to join Gamma Phi Beta. This is a fun time for everyone with games and parties. In the winter, we have the Favorite Guy Party. The sisters invite their "favorite guys" out for a night on us. Pink Carnation Formal is the big event for the Spring. Each year the sisters get dressed up for the banquet where awards are given for everything from academic achievement to who makes everyone laugh the most.

The sisters have so much support and love to offer. Joining a social organization like Gamma Phi Beta not only makes you well-rounded, but it enhances college to make it truly the best years of your life. Since we have Open Rush all year, anytime is the right time to get acquainted with Gamma Phi Beta.



Barbara, the camera's over here

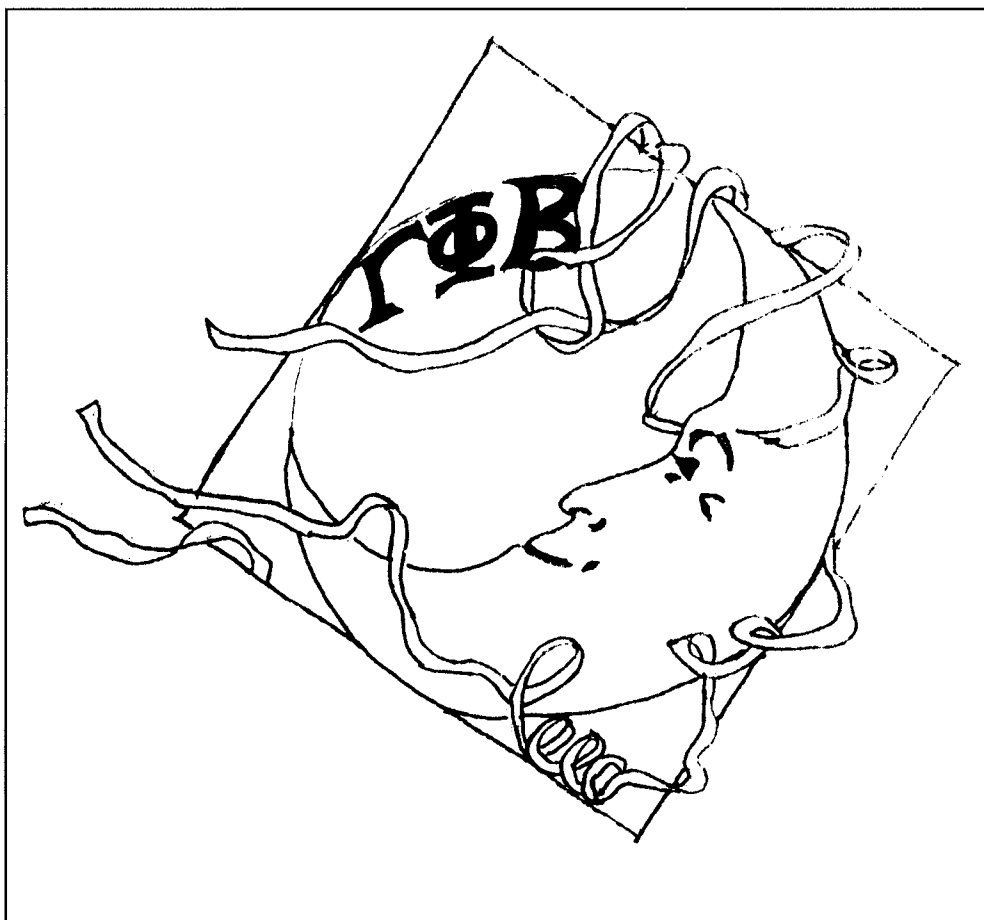



Big-Little Sister Celebration



Favorite Guy Party 1994

TAU KAPPA EPSILON

On January 10, 1899 an organization was formed. An organization designed for men who were tired of having to "fit a mold." It was founded by men who put personal worth and character above wealth, rank or honor. Since that day in January of 1899 the tradition has continued.

"NOT FOR WEALTH, RANK, OR HONOR, BUT FOR PERSONAL WORTH AND CHARACTER."

Tau Kappa Epsilon Fraternity is a group of men who have joined in the bond of brotherhood. With over 300 active chapters, Tau Kappa Epsilon has established itself as the largest fraternal organization in the nation. Also with new colonies and chapters forming in Canada, TKE is well on it's way to becoming a fraternity seen commonly on an international scale.

The Xi Chi chapter at Southern Tech was formed on January 24, 1973 by 57 men. The chapter now has over 400 members on its scroll.

Tau Kappa Epsilon continues to contribute to its community with local blood drives, donating time to Adopt-A-Highway and Special Olympics, Basketball run for Cystic Fibrosis Foundation. TKE also provides year-round activities on and off campus such as our annual Halloween Party, Wild Turkey Party, and Spring Wing Ding.





SIGMA PI

Just like the rock is to Southern Tech, Sigma Pi is foundation. Established on October 28, 1972, the Epsilon Alpha Chapter was the first national fraternity on campus. We have opened the doors for more to follow.

Just like the rock, Sigma Pi is full of tradition — both old and new. Every year in May our brothers look forward to our annual camping trip. This year we started by winning our first annual banner competition against Alpha Phi Chapter (UGA) at our annual Georgia Alumni Club meeting. Also this year our First Annual Sigma Pi Jam Fest for multiple sclerosis hopes to become tradition for Sigma Pi and the rest of Southern Tech students.

Just like the rock has a change of faces each day, Sigma Pi has a diversity of images as well. In Sigma Pi, brothers come from places as near by as Myrtle Beach, S.C., to as far away as Morrocco.

Just like the rock, SigmaPi's faces are different, but their goal the same — "United In Brotherhood."

Though the road has been long and hard, just like the rock we've stood strong. And as old faces go and new ones come, just like the rock, our memory will endure and the spirit of Sigma Pi will live forever. EEES!!!!

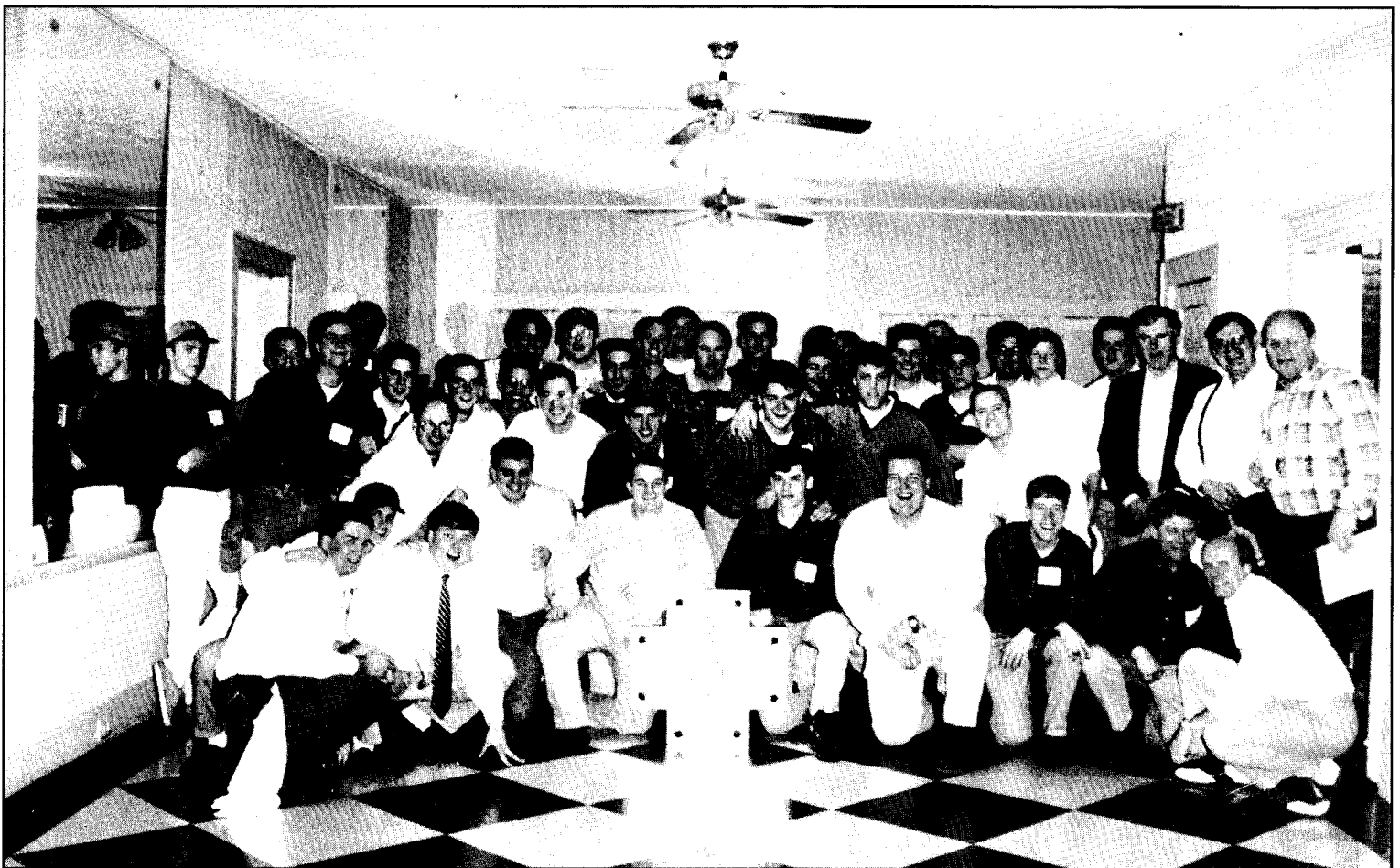

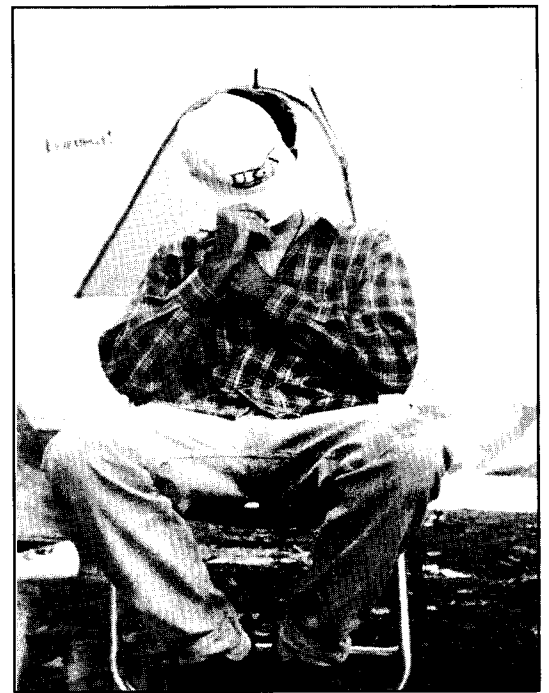

INTERNATIONAL STUDENT ASSOCIATION

The International Student Association (ISA) is an active student organization that meets each Tuesday from 12 noon til 1:00 pm in the Student Center. Its membership is open to all international students including Americans.

Its purpose is to develop friendships and learn about different cultures. The organization sponsors social events, luncheons, educational and cultural programs and an annual International Student Festival. The ISA affiliates with other colleges' international associations and community organizations in the metropolitan area.



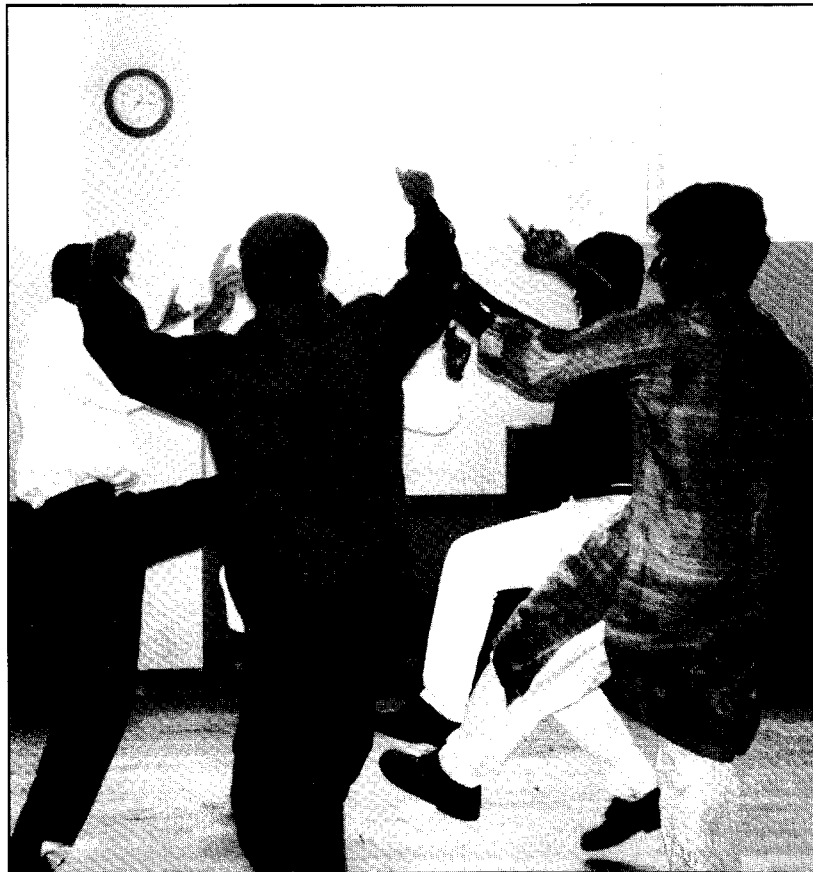
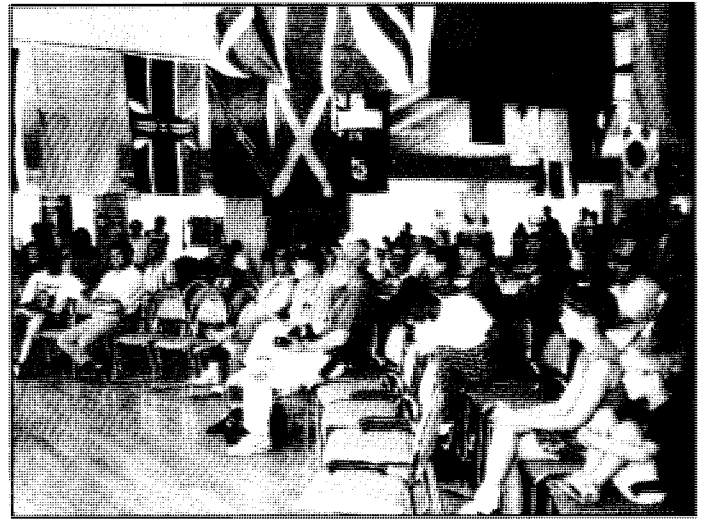

ALPHA DELTA PI

Alpha Delta Pi was the first secret society for college women. On May 15, 1851, the sorority was founded in Macon, Georgia on the Wesleyan Female College campus. The six founding sisters believed that strengthening their own characters and personalities, watching their attitudes toward their fellow beings, recognizing the value of high educational standards, and developing faith and loyalty were high ideals that soon became the principles of Alpha Delta Pi.

The Eta Delta chapter was founded on October 23, 1983. This past October, they celebrated their 10th anniversary on campus. Along with the 10th Anniversary Dance, they held several dances and socials with other fraternities. Alpha Delta Pi was strongly involved in campus activities, as well as, their national philanthropy, the Ronald McDonald House.

Alpha Delta Pi, "the first and finest", has always been a strong national organization. They are proud of their heritage of leadership in the fraternity system exemplified by being among the first to start the new pledgship (Alpha) process in which each sister comes into the sorority with the same privileges and responsibilities as initiated members. They have eliminated the inequality between new and initiated members.

"We Live For Each Other" is their motto, which exemplifies the true friendship, constant support, and never-ending bond that exists between the sisters of the sorority, Alpha Delta Pi.



A "family" shot, at the 10th Anniversary Dance.

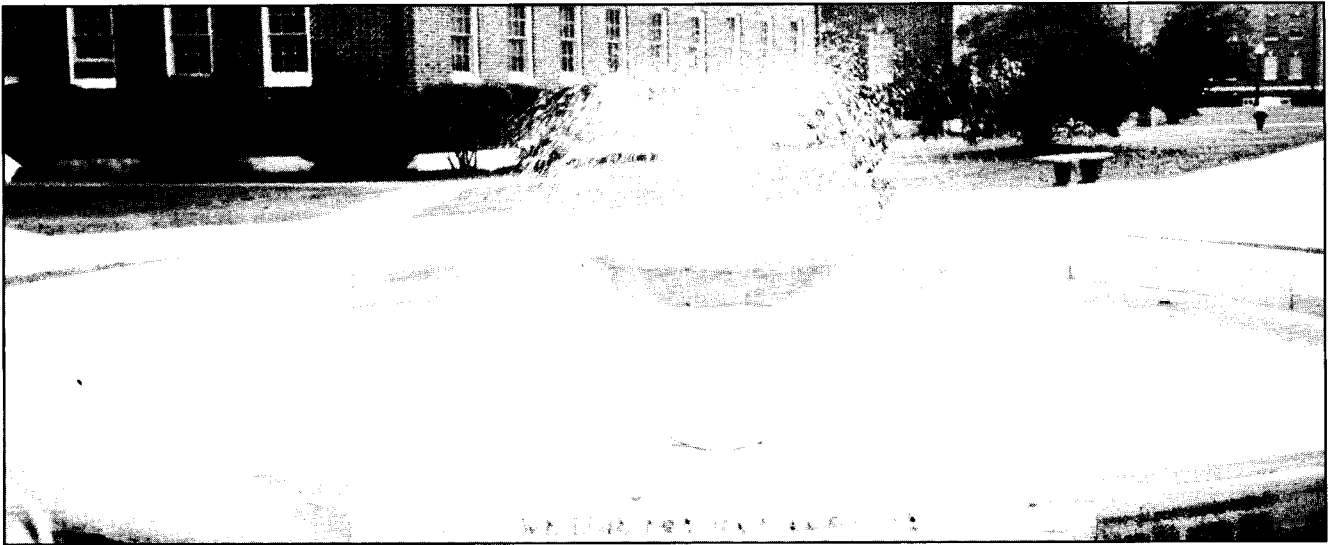

The fountain, bearing the Alpha Delta Pi motto, located at Wesleyan College

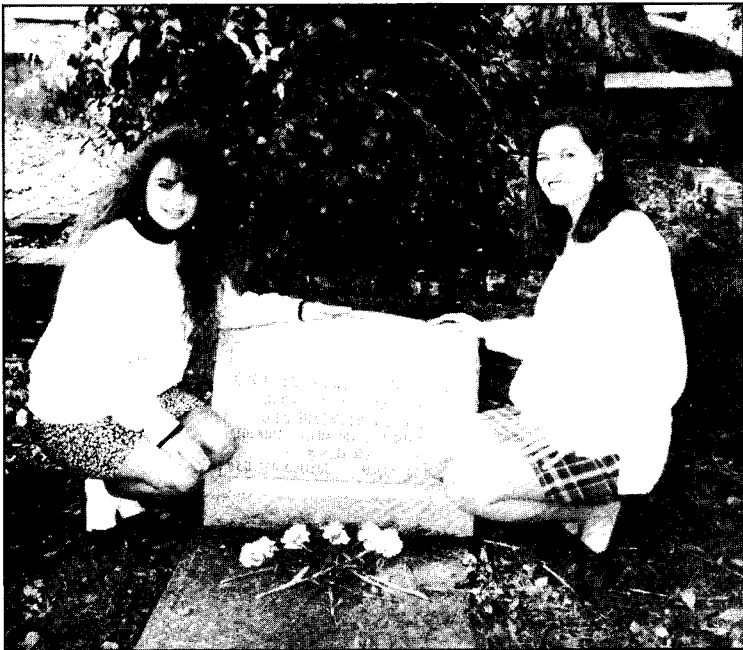

Visiting one of the founding sisters grave site is Angie Perides and Cynthia Clements



Melanie Trammell, Wendy Harper, and Kim Odom enjoying Homecoming '94



A group shot at Black Diamond Formal '94.



Alpha Delta Pi's

PI KAPPA PHI

Pi Kappa Phi Fraternity is an organization dedicated to the building of men personally, physically and academically. In the 93-94 school year Pi kappa Phi earned the second highest GPA among fraternities, first in Goat Night, first in Greek Week, Greek Man of the Year, held president, vice president, and four council positions on Student Government, held positions on Campus Activities Board, chairman of Judiciary Council, and is still the largest and fastest growing fraternity on Campus.

We are not only active on campus, but off campus as well. Through our philanthropy P.U.S.H. (People Understanding The Severely handicapped), we help disabled citizens through visitations to places such as the Reach center. Pi Kappa Phi also attended P.U.S.H. Camp and Give A Push Weekends. This past summer one of our brothers went on The Journey of Hope, which is a handicapped awareness cross country bicycle tour. Our fraternity has raised over 3 million dollars for P.U.S.H. to help build handicapped accessible playgrounds and summer camp facilities.

Our social committee strives to be the best on campus. Since we have our own house that houses nine of our active brothers, we are capable of having large parties. Last year these parties included: our annual Halloween Bash, P and P party, Day-Glow Blowout, Big Hair/Redneck Party, Nuts and Bolts, annual Luau, and the no-theme party. We also had the Wild Wild West II Social with Gamma Phi Beta, and our annual Swamp Bowl with Eta Delta Chapter, which we won again 21-0. We always cap off our year with Roseball. Roseball is our formal dance and recognition dinner for active brothers, alumni, and dates.

Pi Kappa Phi Fraternity embodies brotherhood and involvement is something that can be cherished for a lifetime. Pi Kappa Phi builds leadership and character, but most important, it builds friendships that "nothing shall ever tear asunder". ENOUGH SAID !!!!



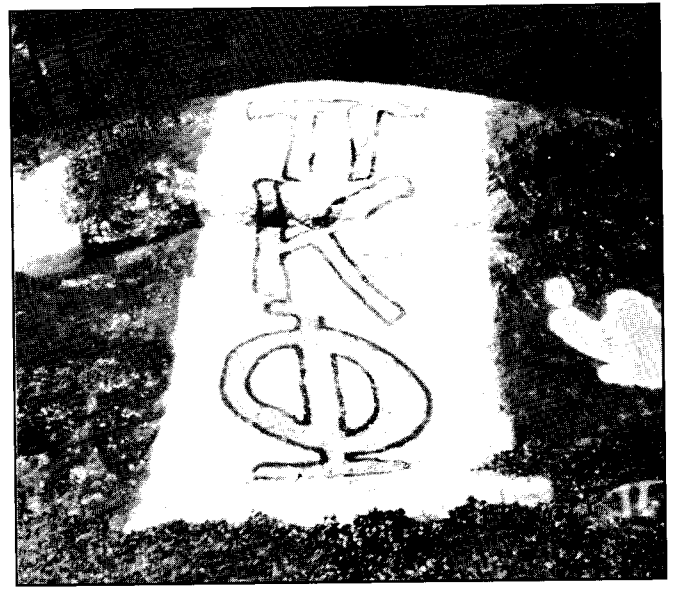
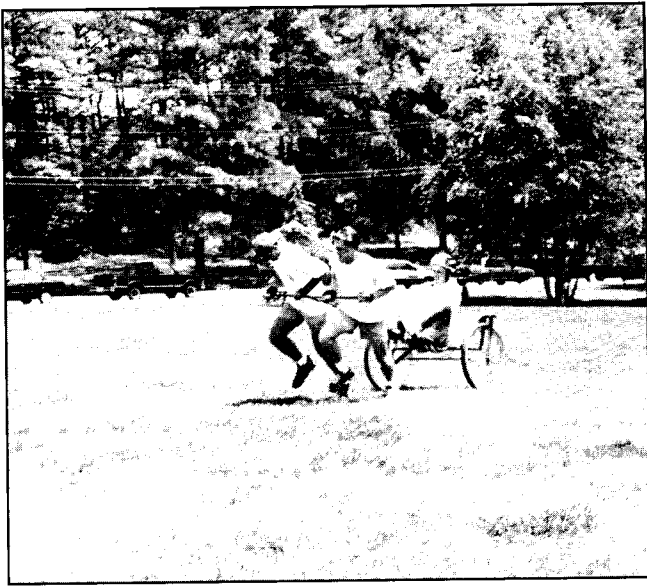

INSTITUTE OF INDUSTRIAL ENGINEERS

The Institute for Industrial Engineers (IIE) student chapter is an exciting way for students to learn about their profession.

IIE is an organization which encourages students to develop contacts for their professional life through meetings, field trips, and Industrial Engineering Magazine, which is published by the Senior Chapter.

Their mission is to promote the profession of Industrial Engineering, to help their members to develop career opportunities, and to keep technology in the Industrial Engineering Technology program.

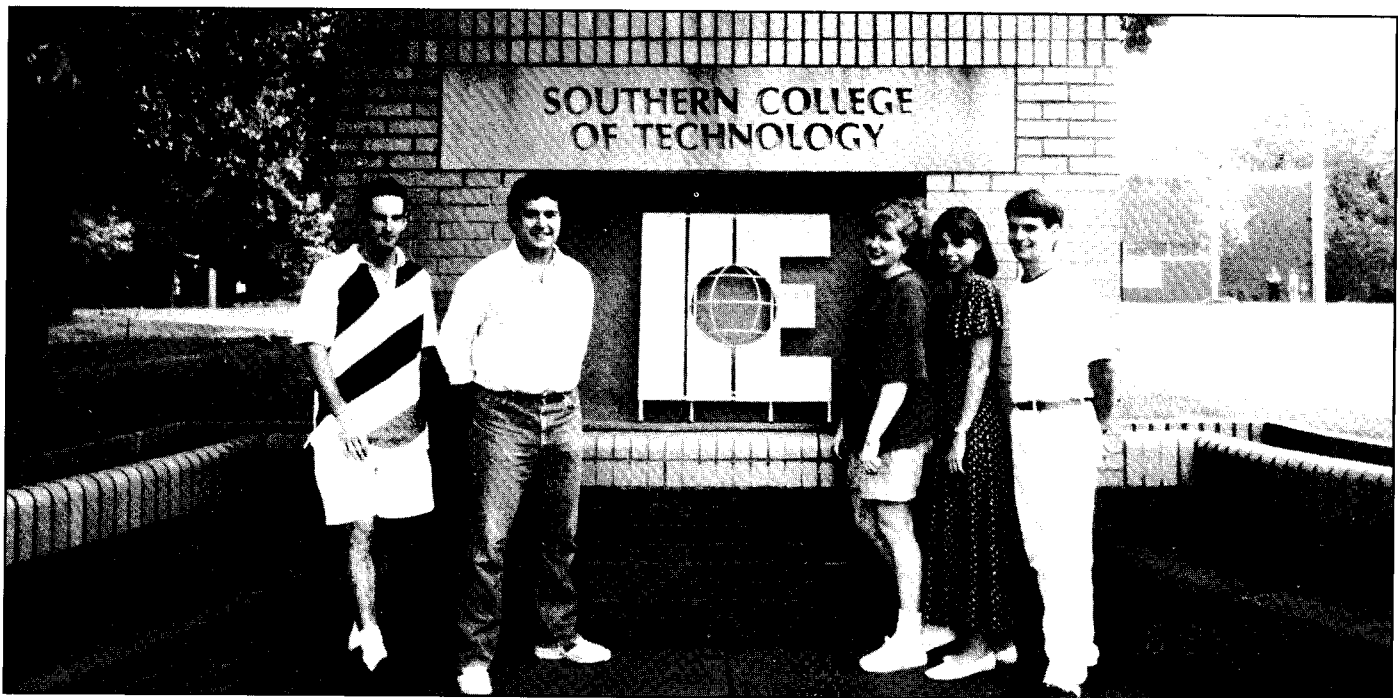

SOUTHERN TECH CYCLING TEAM



Members of the cycling team include: Top Row (L-R) Pat Baltzell, Tony Fahey, John McWhorter, Monty Murphy, Alan Gabrielli (faculty advisor); Bottom Row (L-R) Wes Felteau, Marvin Mayo, Gerald Miller, Brian Rickerson.

Not Pictured: Brad Yeomans, Eddie West, Joe Vinson, Mike Mitchell, Kevin McInturff, Bill Kincheloe, Neal Anderson, Jason Offutt, Jaack hart, Conner Perry, John Boussetot, Sid Carter, Steve Frank, John Andrew, Brian Singleton

STUDENT GOVERNMENT ASSOCIATION



PANHELLENIC COUNCIL

We, The Undergraduate Members of women's fraternities, stand for good scholarship, for guarding of good health, for maintenance of fine standards, and for serving, to the best of our ability, our college community. Cooperation for furthering fraternity life, in harmony with its best possibilities, is the ideal that shall guide our fraternity activities.

We, the Fraternity Women of America, stand for service through the development of character inspired by the close contact and deep friendship of individual fraternity and Panhellenic life. The opportunity for wide and wise human service, through mutual respect and helpfulness, is the tenet by which we strive to live.

The Panhellenic Council is a combination of representatives from each of the two sororities on the Southern Tech Campus. There are a president and a vice-president, which also holds secretary and treasure, one delegate from each sorority and a rush chairman. Panhellenic Council meets every other week to discuss leadership as well as scholastic ideas between the organizations. We try to plan events for the two sororities to participate in together to build our relationships throughout the year.

The annual SEPC (SouthEastern Panhellenic Conference) is held here in Atlanta, which representatives from Southern Tech's Panhellenic Council. The Conference was a great way for us to learn about other schools Panhellenic as well as share our ideas from ours.

This years Panhellenic Council members are:

President: Wendy Harper

VicePresident/Secretary/Treasure: Cindy Quilling

Rush Chairman: Cynthia Clements

Delegate: Cara Baughman

Delegate: Melanie Trammell

WGHR



This was another tremendously successful year for the big wooger: We are still broadcasting, all members of staff got to cop pleas to lesser charges and community service, and last but not least the FCC still doesn't remember granting us a radio station licence. We saw a plethora of new D.J's enter our organization this year and most of them were talented in some way. We also saw the birth of a new radio guru ,the G-Man. Our listening audience grew to even greater numbers thanks to this kind gentleman. We liked his style so much that we made him D.J of the century. WGHR also became a full production studio thanks to the kind students on the SGA. Thanks to: the student activities office, the somber reptile, d.j's and management, tax payers,students ,and last but not least the wonderful wooger alumni even if they never graduated.





LOG

The 1993-1994 Log was headed up by editor Kassia Cato and assistant editor Phil Collins. This was their first attempt at making a yearbook. The book was not without its problems. Many difficulties occurred with the deadlines falling during finals and holidays, major computer problems, staff members graduating, Phil being stuck in flood land Macon. many People contributed to the theme "Right Here, Right Now." They included staff members Ed Hardy, Jen Bige, Jen Waller, Bill Finnick, Jarred Fehr, Shanna Fernandez, Sharon Maddox, Tony Perez, Tonyel Stewart, David Conrad, Leigh Boros, Bryan Tidd, and Dave Dula.

The Photo Editors were Tony Perez, Jarred Fehr, and Dave Dula. The Art Editor was Tonyel Stewart.

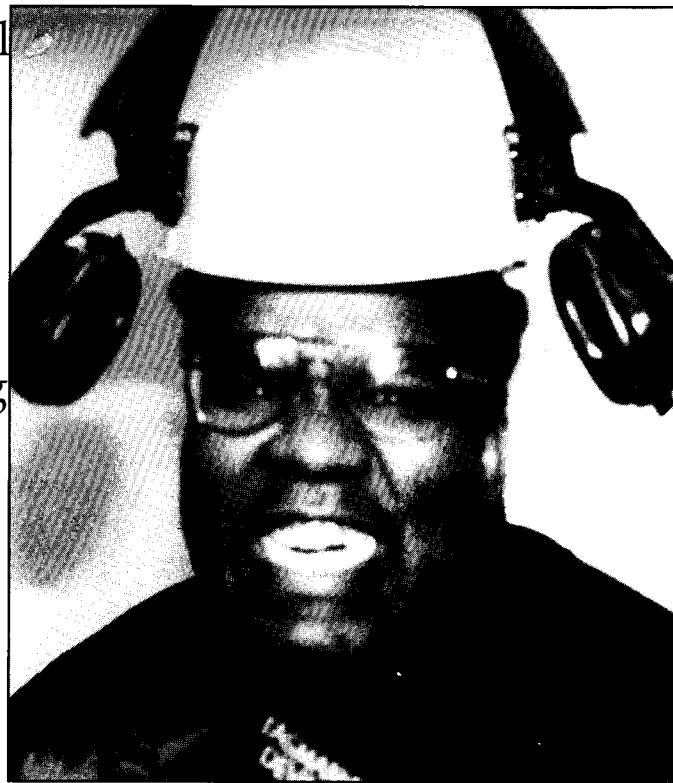

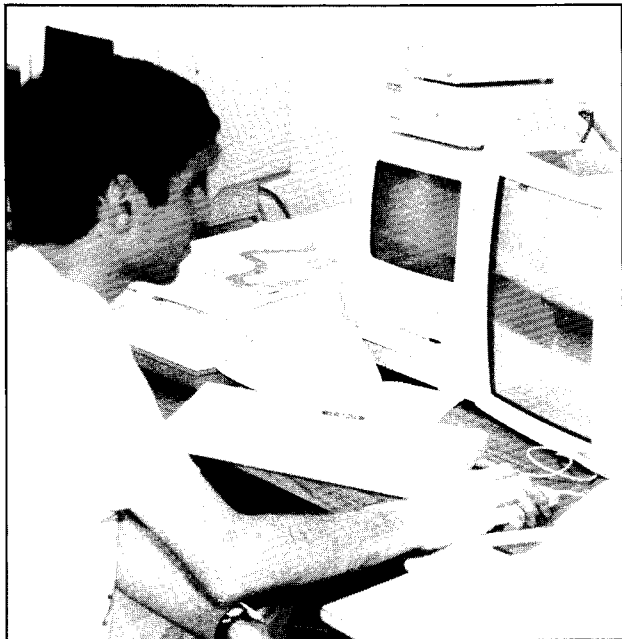
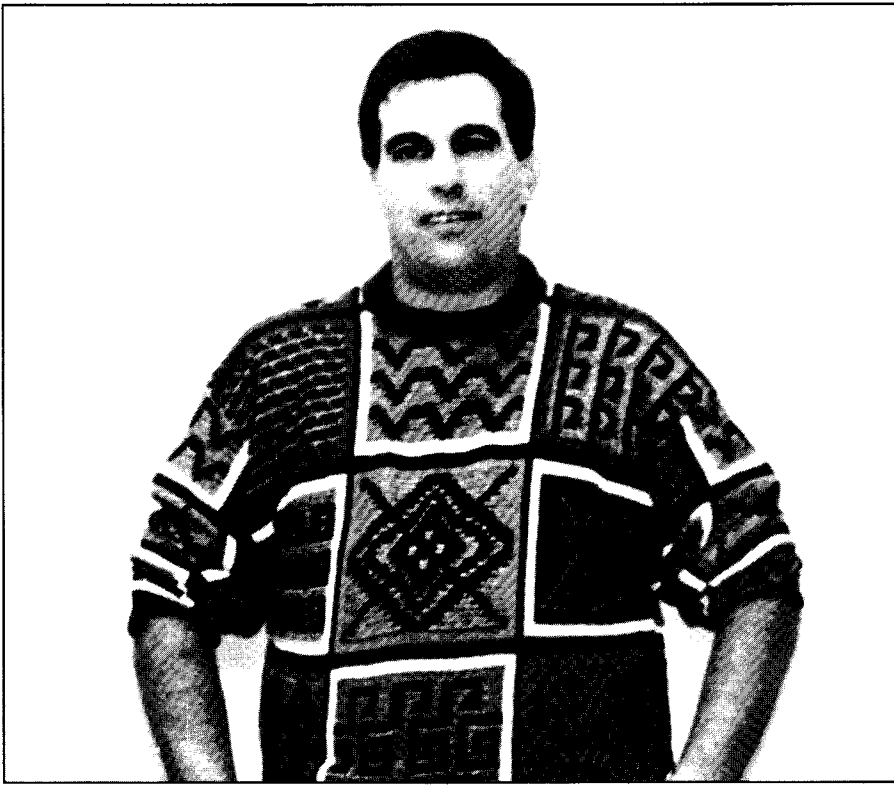

THE STING



This year, The Editor-in Chief of The Sting was Jen Waller. She gathered story ideas and assigned them to writers, ran the meetings, and handled the budget.

Second in command was Bill Greve, the Assistant Editor. He handled all of the advertising, and helped Jen in the overall functioning of the paper.

The Photo Editor position for the 1993-1994 year was filled by two different students, Tony Perez and Jarred Fehr. Tony held the position during summer, fall, and winter, and Jarred took over in spring. The Photo Editor was responsible for making photo assignments, and making sure that the final pictures were printed in time for layout.

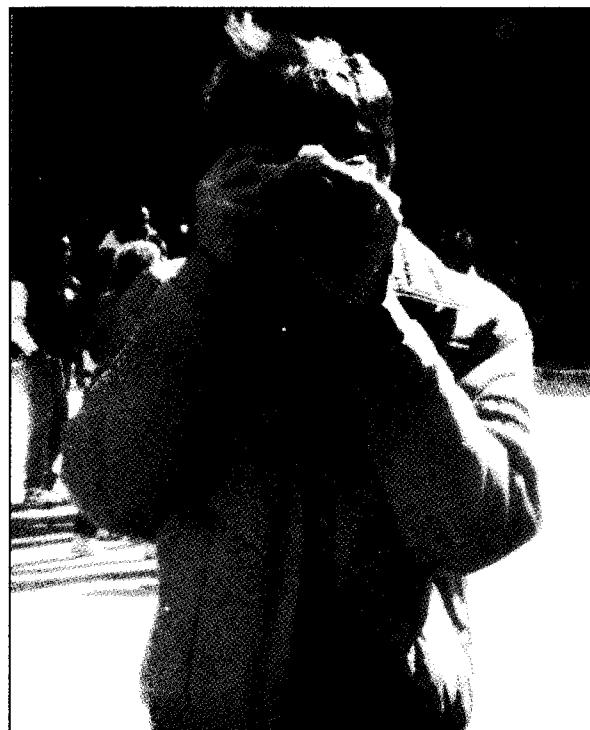



THE BAPTIST STUDENT UNION



BSU at Techfest, the only organization on campus with its own golf course



BSU students ministering to those in need in Winfield Missouri



Students hard at work on Spring Break '94 Missouri Trip



Thursday Nights Together at the BSU

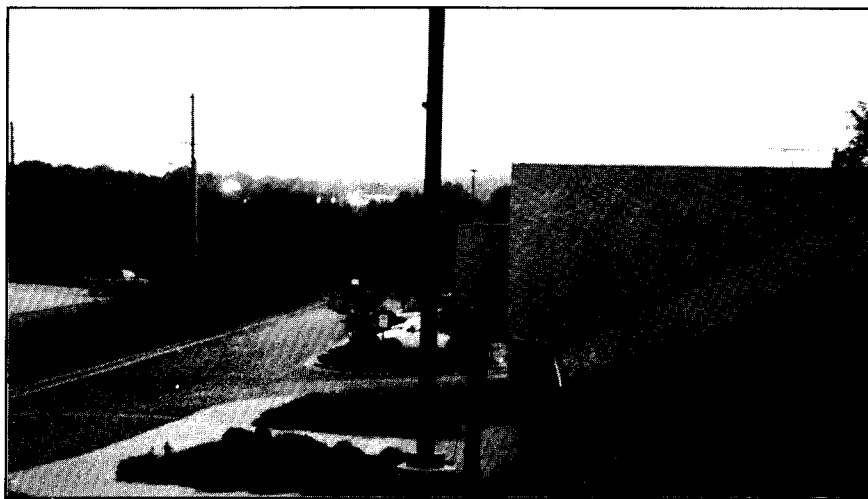

Sunset over the Southern Tech BSU Center

GREEK COUNCIL

The Greek Council of Southern Tech is an organization of members from each greek organization on campus. The Greek Council sponsors such events throughout the year such as Goat Night, which is held in the fall and Greek Week, which is held in the spring. The events are held to promote Greek life and Greek relationships on the Southern Tech campus. This organization is run by the Vice President of IFC (Interfraternity Council) and the Vice President of Panhellenic. There is one representative from each organization to discuss and vote on any joint greek activities. The council has made a huge success on bringing greeks together on campus. The future for Greek Council is even greater with such events planned as "Greek Gatherings" and fund-raisers for local philanthropies.

The 1994 officers for Greek Council are:

Co-Chairman: Kevin Purcell; IFC VP

Co-Chairman: Cindy Quilling; Panhellenic VP

Delegate: Leigh Ann Holton

Delegate: Joanne Moore

Delegate: Jason McRae

Delegate: Therron Womack

Delegate: Pat May

Delegate: Jon Meitz

Delegate: Kirk Voelkel

JUDICIARY



THE DAY STUDENTS CHANGED THE NAME OF THE CAMPUS CENTER BACK TO THE STUDENT CENTER



BEACH PARTY

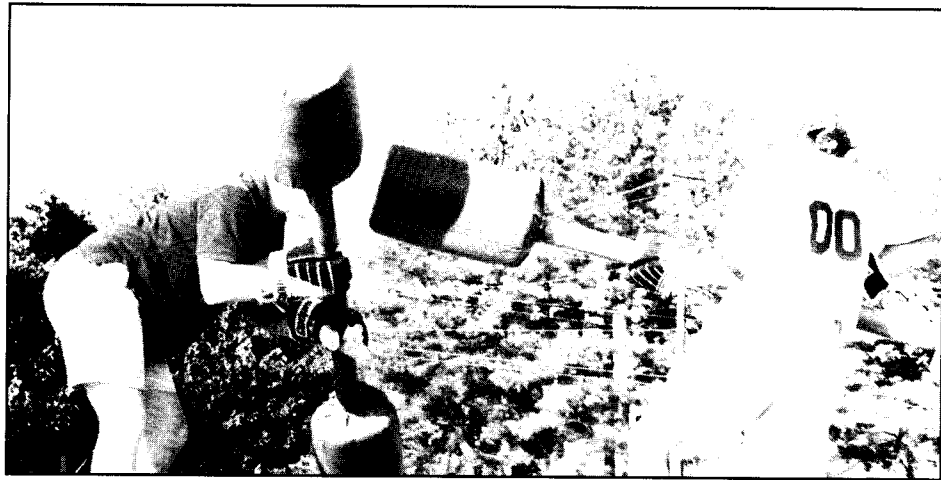

BEACH PARTY

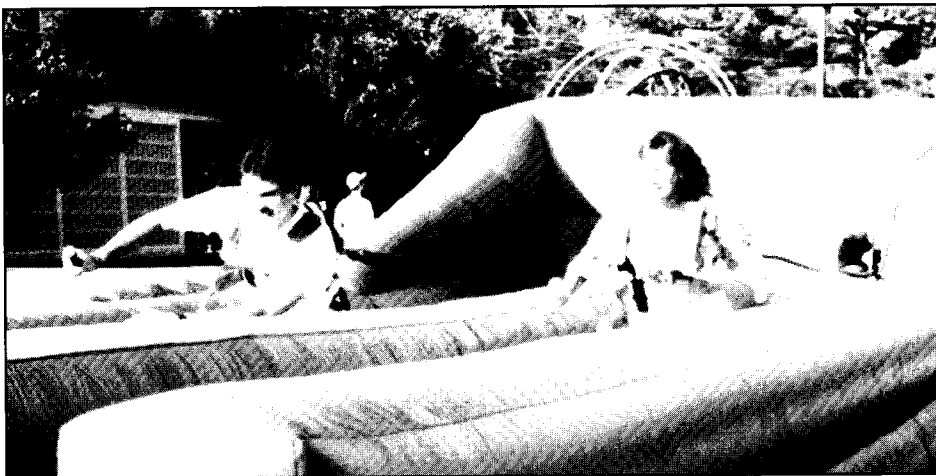

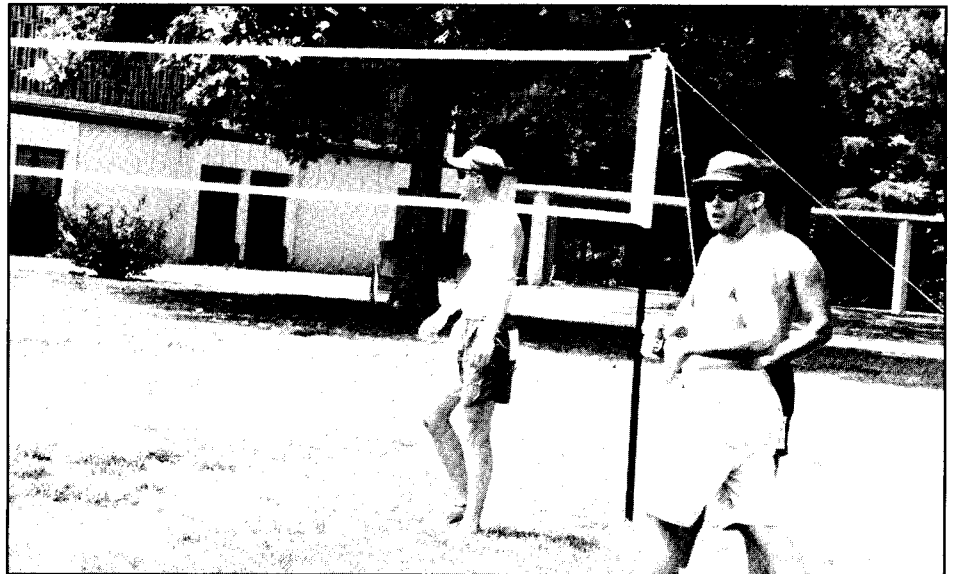
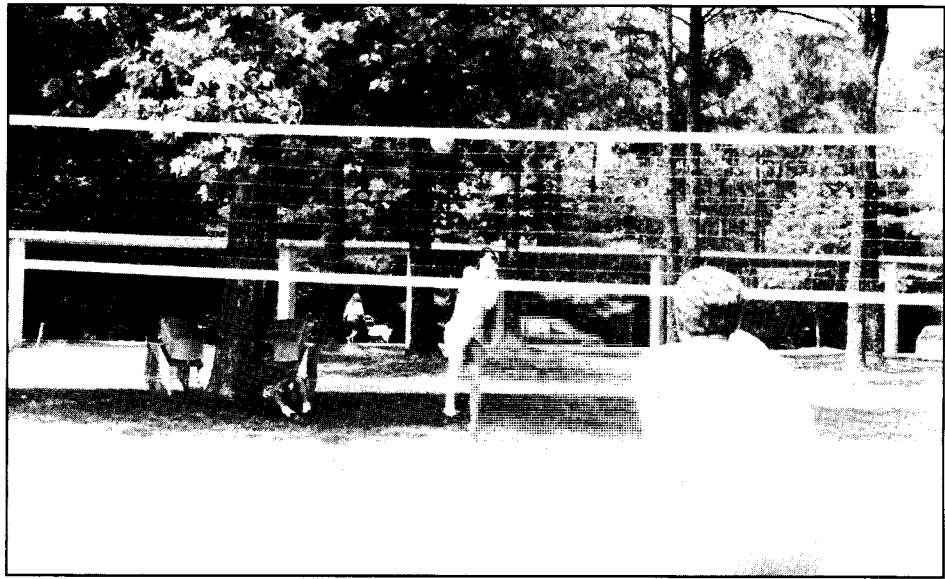

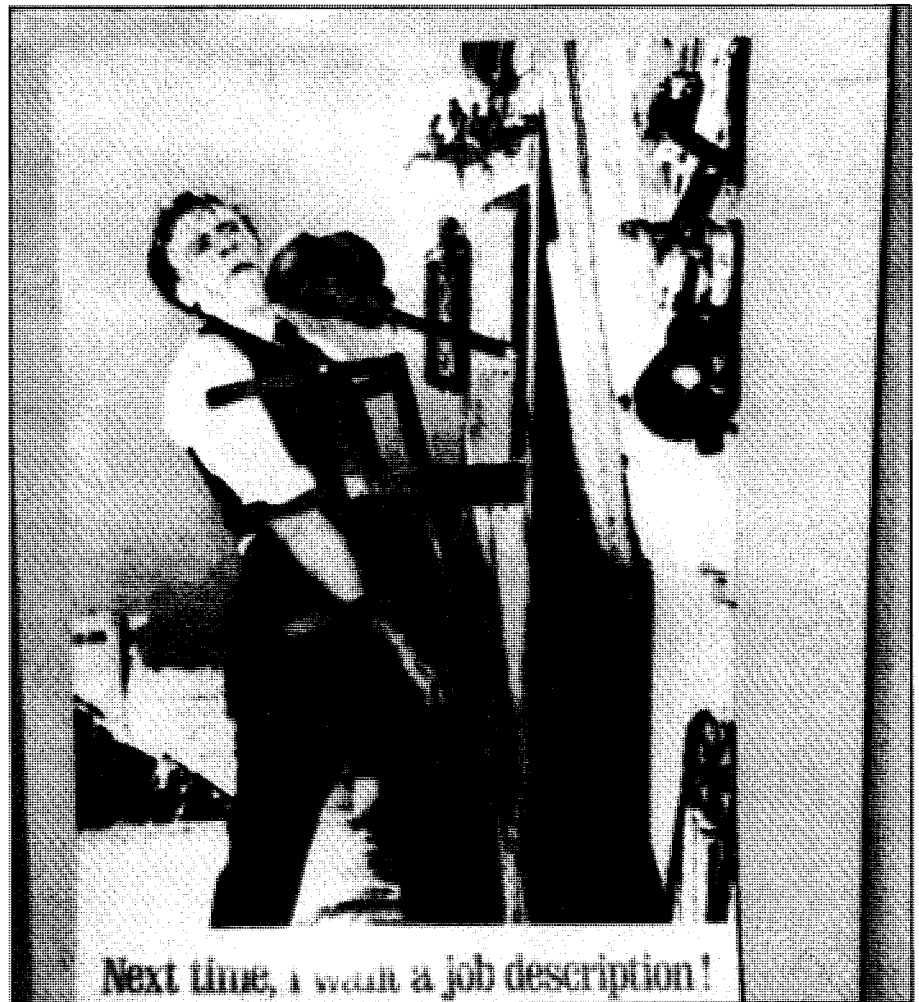
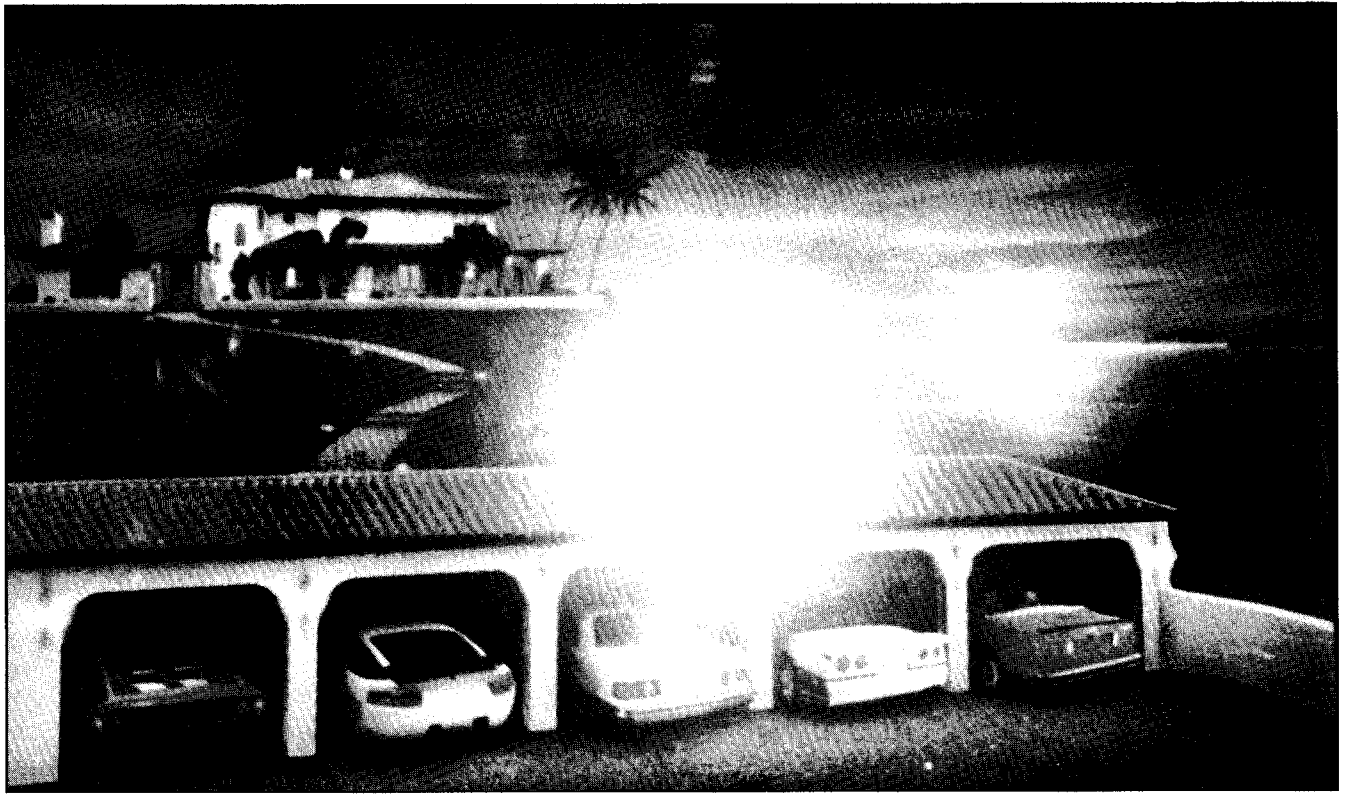



LAW

ENGINEERING AND ENVIRONMENTAL SERVICES

114 TownPark Drive
Kennesaw, Georgia 30144

404-590-4600

SOUTHERN BUSINESS COMMUNICATIONS

AUDIO-VISUAL & IMAGE PROCESSING

JOHN E. BOYETT

3175 CORNERS NORTH COURT • NORCROSS, GEORGIA 30071
404-449-4088 • 1-800-849-4088 • FAX 404-449-0188

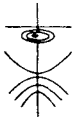

(404) 873-2152
BOB CUNNINGHAM
Architect

Cunningham Forehand Matthews & Moore Architects, Inc.

2011 MANCHESTER STREET, N.E. • ATLANTA, GEORGIA 30324



Recycled paper

BROWNING-FERRIS INDUSTRIES

Lang Herndon
District Manager
Atlanta District

3045 Bankhead Hwy. NW (30318)
P.O. Box 93097
Atlanta, GA 30377

(404) 792-2660
Fax: (404) 792-4477



MAINTENANCE EQUIPMENT COMPANY MAINTENANCE CONSULTANTS

OFFICE 404-938-1970
800-225-8320 (CAL MECO) FAX 404-938-8302
HOME 404-447-8582

AL HUDSON

2110 TUCKER INDUSTRIAL RD.
TUCKER, GEORGIA 30084

LASHLEY, VAN HORNE AND NEUMAN

Consulting Engineers

STEVEN C. LASHLEY, P.E.

1800 Cedars Rd., Suite 102 Office (404) 962-0878
Lawrenceville, GA 30245 Digital Beeper (404) 383-5931

OFFICE: 422-4112



HILL CREST PLAZA RENTAL MOBILE HOMES MOBILE HOME SPACES-FURNISHED APTS

PATIOS • PAVED STREETS • STREET LIGHTS

BARBARA McMAHAN

1150 ATLANTA RD
MARIETTA, GA 30060



Logo'd Merchandise

Fred Williams

1400 South Marietta Parkway Phone (404) 427-4900
Marietta, GA 30067 Fax (404) 425-4520

W.L. JORDEN & CO., INC.



ENGINEERS • SURVEYORS • PLANNERS
ATLANTA 320-1001 LAWRENCEVILLE 962-0443
MARIETTA 426-1844



Ruben N. Rodriguez, Jr.

LOS AMIGOS TORTILLA MFG., INC.

251 ARMOUR DRIVE, N.E.
ATLANTA, GEORGIA 30324-3979
U.S.A.

PHONE (404) 876-8153
1-800-969-TACO
FAX (404) 876-8102



Cedartown: (404) 748-4016
Atlanta: (404) 688-4347
FAX: (404) 748-4017

William Benefield & Asso., Inc.

GENERAL CONTRACTOR

BARRY BENEFIELD
Estimator / Secretary

P.O. Box 121
1555 Rockmart Highway
Cedartown, Georgia 30125

Coffee's Gym (404) 952-1744

1033 Franklin Rd. • Marietta, Georgia



Complete Weight Training
Facility for Men & Women

Individualized Programs
Freeweights and Machines
Steam and Sauna

Samson Tours

Your Tour Guide for the United States and Canada!

Escorted Motorcoach Charters for business, civic, schools and church groups.

1320 Milledge Street • East Point, Georgia 30344
(404) 768-TOUR (8687) • 1 (800) 899-2369
FAX: (404) 763-8992

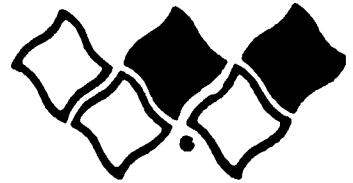

All Students Receive 10% Discount With Student I.D.

SEARS Resume Service

- Professional Resumes
- National Resume Network
- Free Consultations

JUDITH E. SPERRY
Resume Consultant

Town Center at Cobb
400 Barrett Parkway
Kennesaw, GA 30144
(404) 423-7448



SALES • RENTALS • REPAIRS

OPTICAL ENGINEERING COMPANY, INC.
710 DAVIS CIRCLE
MARIETTA, GA 30060

HOWARD GRANT

(404) 427-3116
GA & S.E. WATS
1-800-282-7989
FAX (404) 424-3488



Jordan Jones & Goulding
INCORPORATED

2000 CLEARVIEW AVE., N.E.
ATLANTA, GEORGIA 30340
PHONE: (404) 455-8555
FAX: (404) 455-7391

*Comprehensive
engineering services,
specializing in the
environmental
field.*

(404) 428-1517
FAX: (404) 426-7277



CONTRACT MANUFACTURING
AND PAINTING
SINCE 1953

P.O. BOX 6248
MARIETTA, GEORGIA 30065

823 DAMAR ROAD, N.E.
MARIETTA, GEORGIA 30062

BOUNDARY SURVEYS
LOAN SURVEYS

SUBDIVISION DESIGN
CONSTRUCTION SUPERVISION

Perimeter Surveying Co., Inc.

1065 SANDTOWN ROAD, SW
MARIETTA, GEORGIA 30060

KEN NUTT

421-1186

GOODYEAR

GOODYEAR TIRE CENTER
3378 CANTON HWY.
MARIETTA, GA 30066

ROY G. HOLBERT
MANAGER

PHONE: (404) 427-0234

HNTB ARCHITECTS ENGINEERS PLANNERS
The HNTB Companies

200 Northbeck, Suite 400
3715 Northside Parkway, N.W.
Atlanta, Georgia 30327
(404) 237-1531
FAX (404) 231-1415

JAMES L. DRINKARD, P.E.
Vice President



KENDALL & ASSOCIATES, INC.

Soil and Ecological Consultants

Robert L. Kendall, CPSS
President

109 Anderson Street
Suite 100
Marietta, Georgia 30060

(404) 423-7224
FAX (404) 590-9760
Mobile (404) 550-7178



SUPER 8 MOTEL — ATLANTA/MARIETTA

2500 Delk Road • Marietta, GA 30067
PHONE: 404-984-1570 • FAX: 404-933-9382

SANDY MULLINS
General Manager

North America's Finest Economy Lodging.

For Toll Free Reservations: 1-800-800-8000

This property is independently owned and operated pursuant to a franchise agreement with SUPER 8 MOTELS, INC.



COMPLIMENTS OF

**metro
REFRIGERATION
SUPPLY, INC.**

3901 Green Industrial Way
Chamblee, Georgia 30341

—WHOLESALE ONLY—
(404) 458-9514





GARRISON PLANTATION

Altha Yancey Bailey
Project Manager

(404) 427-2157
(404) 425-5962 FAX

880 South Cobb Dr.
Marietta, GA 30060



GLENN RAINWATER
SALES PROFESSIONAL



JOHN BLEAKLEY FORD
870 Thornton Rd.
Lithia Springs, GA 30057
(404) 941-9000 - Office
(404) 948-5659 - Home



W.L. THOMPSON CONSULTING ENGINEERS, INC.

3475 Lenox Road, N.E.
Suite 300
Atlanta, Georgia 30326



GENERAL CONTRACTORS
4806 Wright Drive • P.O. Box 2476
Smyrna, Georgia 30081
(404) 432-2900



A DIVISION OF WILLCOX & GIBBS, INC.

**Distributor of Equipment,
Parts and Supplies
to the Sewn Products Industry.**

3900 Green Industrial Way, Atlanta, GA 30341
(404) 455-0664, (800) 241-6800 FAX: (404) 452-8784, (800) 228-7550



Allstar Rent-A-Car, Inc.
1199-B Roswell Road
Marietta, GA 30062
(404) 428-6240

Nationwide Toll-Free Reservations 800-272-U-SAV

U - S A V E A U T O R E N T A L

BEN MEADOWS COMPANY

Equipment for Natural Resource Managers



3589 BROAD STREET, ATLANTA, GEORGIA 30341
phone 404 • 455 • 0907 | fax 404 • 457 • 1841



Smith Brothers B.P. Service Station

BP OIL

591 S. Marietta Parkway
Marietta, Georgia 30060
Phone: 404-428-9316
Fax: 404-428-7950

STEVENS & WILKINSON

ARCHITECTURE • ENGINEERING • INTERIOR DESIGN

STEVENS & WILKINSON OF GEORGIA, INC.
100 PEACHTREE STREET ATLANTA, GA 30303-6801
OFFICE 404/522-8888 FAX 404/521-6204



TEL (404) 421-1631
FAX (404) 514-9121

GARY FRANK
MANAGER

MAACO AUTO PAINTING & BODYWORKS
1350 S. MARIETTA PARKWAY MARIETTA, GA 30067



THE BOX WAREHOUSE

1199-B Roswell St.
Marietta, GA 30062
(1/4 mile East of Big Chicken)

8:00 a.m. - 6:00 p.m.

(404) 422-8888

LAND SURVEYORS
CONSULTING ENGINEERS

SUBDIVISION DESIGN
CONSTRUCTION SUPERVISION

HANNON, MEEKS & BAGWELL

SURVEYORS AND ENGINEERS, INC.
P.O. BOX 1207
238 BUFORD DRIVE
LAWRENCEVILLE, GA. 30246

(404) 963-7181

G & C LAWN EQUIPMENT

"One Of The Largest Selections Of Commercial Mowers In Cobb County"

SALES — SERVICE — PARTS
COMMERCIAL / RESIDENTIAL

• MOWERS • TRIMMERS • TILLERS
• EDGERS • BLOWERS •
PICK-UP & DELIVERY

422-3110

535 N. COBB PKWY
1 MI NORTH OF BIG CHICKEN ON LEFT

RANSOMES
DOB-CAT

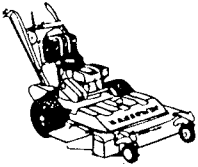

MARIETTA DODGE, INC.

"Under the Big Dodge Dome"

701 Cobb Parkway South
Marietta, Georgia 30062

(404) 424-6580



ENGINEERS & DESIGNERS



Personnel Department
Simons-Eastern Services, Inc.
P.O. Box 1286 • Atlanta, GA 30301

An Equal Opportunity Employer

ELECTROMAGNETIC SCIENCES, INC.

660 Engineering Drive
Technology Park / Atlanta
P.O. Box 7700
Norcross, GA 30091-7700

Tel: (404) 263-9200

FAX: (404) 263-9207



AMITECH
1040 Cobb Industrial Drive
Marietta, Georgia 30066

STORK GAMCO, INC.

Poultry Processing Systems



Airport Parkway
Gainesville, GA 30501
404-532-7041 • Fax: 404-536-0585

*Partners with the Poultry
Processing Industry for 50 years!*

Health care you
can count on.

For life.



HEALTHDYNE®

1255 Kennestone Circle
Marietta, Georgia 30066
(404) 499-1212



Suite 720, 1850 Parkway Place
Marietta, Georgia 30067
Engineers and Consultants 404/425-8100



APAC-GEORGIA, INC.
MacDOUGALD-WARREN DIV.

ATLANTA
311 Port Cobb Drive., Smyrna
351-4430

6 PLANTS SERVING THE METRO AREA AND COLUMBUS

FOREST PARK 767-8412	KENNESAW 422-1530	LITHONIA 482-7238	NORCROSS 279-1356
FORSYTH (404) 889-8112		COLUMBUS (706) 322-1401	

ES ENGINEERING-SCIENCE, INC.

A Subsidiary of The Parsons Corporation

57 Executive Park South, N.E., Suite 500
Atlanta, Georgia 30329-2265
Telephone: 404/235-2300

VININGS



INDUSTRIES

Vinings Industries, Inc.
3950 Cumberland Parkway, Atlanta, Georgia 30339

ISO 9002
REGISTERED

EXCELLENCE...
A FIRM COMMITMENT
TO THOSE WHO
PURSUE IT

Management consultants to America's most
successful firms for over 15 years.

Coopers
& Lybrand

 **SYSTECON**
Management and Engineering
Consulting Services

400 Northridge Road, Suite 1000 • Atlanta, GA 30350-3328
(404) 643-5100



CENTRAL FOOD
MANAGEMENT

1870 MURPHY AVENUE
ATLANTA, GEORGIA 30310

CARPET TRANSPORT, INC.



Serving
The Floor Covering
and
Textile Industry

Congratulations Southern Tech Graduates

495 Lovers Lane Road, S.E.
P.O. Box 7
Calhoun, GA 30701

Georgia's Source for Engineering Excellence

TRANSPORTATION • ENVIRONMENTAL

CIVIL ENGINEERING • SURVEYING

PBSJ POST,
BUCKLEY,
& SCHUH &
JERNIGAN, INC.

1575 Northside Drive, Suite 350 • Atlanta, Georgia 30318-4203
Telephone: 404/351-5608

(404)455-9375

MA

FAX (404)454-7196

Moreland Altobelli Associates, Inc.

**4000 DeKalb Technology Parkway
Building 300, Suite 370
Atlanta, Georgia 30340**

Transportation Engineering • Environmental Engineering • Water & Sewer
Construction Management • Structural Engineering • Geotechnical • Planning
Civil/Site Engineering • Solid Waste • Landscape Architecture • Architectural
Hydrology Studies • Land Acquisition • Surveying • Program Management
Atlanta • Cobb • Gwinnett • Gainesville • Savannah

COMPLIMENTS OF

SULZER | Papertec

AUSTELL, GEORGIA

LOCKWOOD GREENE

Planners/Engineers/Architects/Managers

**Designing America's Workplace
Since 1832**

800-845-3302

Atlanta • Dallas • New York • Oak Ridge • Spartanburg

THE STUDENT CENTER.



Going to McDonald's® is almost as much a part of school as going to class. You've made us the place to meet, to talk, to have a good time, to celebrate your victories and help forget defeats.

You've made McDonald's more than just another place to eat. And that's why, at McDonald's, we say...

**IT'S A GOOD TIME
FOR THE GREAT TASTE**

© 1987 McDonald's Corporation



CG

C&G SOFTWARE SYSTEMS, INC.
LAND SURVEYING SOFTWARE BY LAND SURVEYORS

Offering a complete line of surveying software products:

CG-SURVEY FOR DOS®

Stand-alone product offering electronic data collection to finished plot with no other software required.

CG-SURVEY FOR MICROSTATION®

An MDL application requiring Intergraph's MicroStation. Brings REAL land surveying to MicroStation.

CG-SURVEY FOR AUTOCAD®

An ADS application requiring AutoCAD Release 12 or later. It provides the surveying you couldn't get for AutoCAD before.

Let our sales staff fill your needs.

7094 Peachtree Industrial Blvd. • Suite 352 • Norcross • GA • 30071 • USA • (404) 446-0026 • FAX (404) 447-0530

CIVIL DESIGN, INC.

ENGINEERS, LANDSCAPE ARCHITECTS, PLANNERS AND SURVEYORS

JOHN E. DIDICHER
President

750 Hammond Drive, Bldg 10, Suite 100, Atlanta, Georgia 30328
(404) 252-1334



TEXTILE PERFORMANCE CHEMICALS
WATER SOLUBLE POLYMERS

1000 Hurricane Shoals Rd
Lawrenceville, GA 30243

HARTRAMPF

Engineers & Surveyors

Hartrampf Engineering
180 Allen Road NE / Suite 217
Atlanta, Georgia 30328-4842
Telephone 404 252-2063



*The NATIONAL LIBRARY
BINDERY COMPANY*
OF GEORGIA, INC.
Specialist in
LIBRARY, EDITION AND
LEATHER BINDINGS

J. T. Tolbert
President

P.O. Box 428, Roswell, GA 30077
100 Hembree Park Drive, Roswell, GA 30076
(404) 442-5490/1-800-422-7908/FAX: (404) 442-0183

Congratulations

1994

Graduates

Law Companies Group

Sharian

368 West Ponce de Leon Avenue
Decatur, Georgia 30030
(404) 373-2274

FOR ALL YOUR PLUMBING, PIPEFITTING, HEATING & AIR CONDITIONING NEEDS



If you demand **QUALITY WORK**,
done by **PROFESSIONAL CRAFTSMEN**
who take **PRIDE IN THEIR WORK...**

There's Only One Place To Go:
**PLUMBERS, PIPEFITTERS &
SERVICE TECHNICIANS
LOCAL UNION 72**

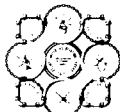

(404) 373-5778
374 Maynard Terrace, S.E.
Atlanta, Georgia 30316

OPTICAL ENGINEERING CO., INC.

SUPPLIES AND EQUIPMENT FOR:



K-O-E



LIETZ

- Engineers
- Surveyors
- Draftsmen



- SCHONSTEDT
- GURLEY
- PENTAX
- DAVID WHITE
- NIKON
- E.D.M.
MEASURING
EQUIPMENT

SALES

REPAIRS ON ALL MAKES
Factory Authorized Repairs
ENGINEERING SUPPLIES

AREA CODE: 404
427-3116

RENTALS

IN GEORGIA CALL TOLL FREE!
1-800-252-7989
SOUTHEAST CALL TOLL FREE 1-800-647-3653
710 Davis Circle, S.W. • Marietta, Ga. 30060

CTG

Meeting the Challenges of the '90s

Through a solid commitment to innovative information solutions, Computer Task Group is at the forefront of our industry. As a professional services firm with 65 offices and over 4000 full-time professionals, CTG's expertise is sought by Fortune 500 corporations to plan, design, and implement their information systems.

Excellent career opportunities exist for experienced Programmers • Programmers/Analysts • Systems Analysts who thrive on challenge and diversity.

CTG offers a competitive salary and a comprehensive benefits package. If you have proven experience and a desire to work for an exciting, vibrant company, then CALL or RUSH your resume to: **COMPUTER TASK GROUP, 100 COLONY SQUARE, ATLANTA, GA 30361**
(404) 870-2300
Equal Opportunity Employer



Dr. R. Wayne Gaby
Chiropractor

1135 South Marietta Parkway
Marietta, Georgia 30060

404/422-9288

**JIM
TIDWELL**



Phone: 427-5531

**FORD 2390 Cobb Parkway
Kennesaw, Georgia 30144**



10'
SCREEN

The Beer Mug

Shuttle
Service to
Braves
Games
Available

Since 1968
One of Atlanta's and Buckhead's oldest &
friendliest neighborhood sports bars and
entertainment spots.

"Special Low Prices on Bottle Beer on Friday's
and Sat. (.10¢ Wings on Sun.)

1705 Peachtree St. • Atlanta, GA 30309 • 874-7836



nplas

ENPLAS (U.S.A.), INC.

2000 Windy Hill Road
Smyrna, GA 30080
Phone (404) 435-3131
Fax (404) 435-2447

BERKEL & COMPANY



CONTRACTORS, INC.
7300 MARKS LANE
AUSTELL, GEORGIA 30001
(404) 941-5100

CONSTRUCTION ENGINEERING ASSOC.
934-6700

Site Planners
Land Surveyors

Site Development
Construction Management

MILTON R. LEMON
O. EUGENE KAY

2030 Tucker Industrial Road
Tucker, Georgia 30084

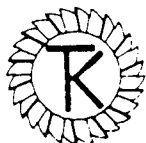

TRU - KUT, Inc.

ROBERT T. GUNTER
PRESIDENT

1121 SPRING ST., N.W.-ATLANTA, GA 30309

TEL. 404-873-4341

GA. WATS No. 800-282-4061

OTHER STATES 800-241-6365

EARTH PRODUCTS

NATURAL STONE

LUKE WILLIAMS
CATHY ALMAND
404/424-1479

515 COBB PARKWAY, N.E.
MARIETTA, GA 30062

**JOHNSON
CONTROLS**

*JOHNSON CONTROLS is dedicated to the ideals
and practice of equal opportunity.*

Johnson Controls, Inc. • Controls Group
650 Wharton Drive, S.W. • Atlanta, Georgia 30336
Tel. 404/696-2590 • FAX 404/696-3754

WILLIAMSON BROS. BAR-B-Q

THE ORIGINAL
WILLIAMSON BROS.
BAR-B-Q
MARIETTA, GEORGIA



1425 Roswell Rd. • Marietta GA • 971-7748 • 971-3201

INTTEGRATED
SCIENCE &
TECHNOLOGY, INC.

1349 Old Highway 41, Ste 225
Marietta, Georgia 30060
(404) 425-3080 • FAX (404) 425-0295

William T. Stephens Constuction Co., Inc.

BILL STEPHENS
President

MIKE STEPHENS
Vice President

BUILDER / DESIGNER
6080 McDONOUGH DRIVE
SUITE C
NORCROSS, GEORGIA 30093
(404) 448-0995

YKK

Little Parts. Big Difference

Manufacturers of plastic and metal zippers, Cosmolon hook & loop, Fastenmates plastic notions, and polypropylene and polyester Webbing. YKK supports the sewn products industries and salutes the students of Southern Tech!

YKK (U.S.A.) Inc. is a subsidiary of YKK Corporation.

PAUL W. HEARD & COMPANY

Mechanical Contractors

P.O. Box 20727

Atlanta, Georgia 30320

404/559-3300

Congratulations,
Southern Tech Graduates
Think About **LIFE** After Tech!

Life  **College**

School of Chiropractic

School of Undergraduate Studies

School of Graduate Studies

1269 Barclay Circle

Marietta, Georgia 30060

(404) 424-0554

Stevenson & Palmer Engineering

INCORPORATED

2430 Herodian Way

Smyrna, GA 30080

(404) 952-2481

116-A Roosevelt Avenue

Albany, GA 31701

RANDALL BROTHERS, INC.

Building Materials, Redwood, Pressure-treated Lumber
& Plywood, Cork, Deck Screws, Doors, Hinges,
Locks, Lumber, Nails, Windows and Much More!

Our 110th Year
10% Discount Off Our Everyday Retail
Price With Southern Tech ID.

665 Marietta Street, NW • Atlanta, GA 30313 • (404) 892-6666

EPATILLO

CONGRATULATIONS GRADUATES

The Patillo Companies
5830 E. Ponce De Leon Ave.
P.O. Box 67
Tucker, GA 30085

Georgia Land Surveying Co., Inc.

Josh L. Lewis III
Land Surveyor #1751

155 Cliftwood Drive
Atlanta, Georgia 30358
(404) 255-4671

Simco

Bill Simpson Jr., IE, '66

Providing Technical Products to Industry

Fluid Power

Power Transmission

Material Handling

Industrial Electronics

Locations In

ATLANTA

SAVANNAH

COLUMBUS

NORCROSS

Phone Number

404-729-9100

Welcome to
Personal Banking.
Welcome to Wachovia.

WACHOVIA

Member FDIC



Flexible Products Company

1007 Industrial Park Drive N.E.

Marietta, GA 30061

(404) 428-2684

Gaskins Surveying Co., Inc.
Land Surveying Subdivision Layout
1266 Powder Springs Road
Marietta, Georgia 30060
Phone 424-7168

John C. Gaskins



Marietta
POWER
Dependable Electric Energy

P. O. BOX 609

205 LAWRENCE STREET

MARIETTA, GEORGIA 30061



METRIC

CONSTRUCTORS

Southeast Division
Two Parkway Center
1800 Parkway Place, Suite 810
Marietta, Georgia 30067
Telephone: 404 428 4999
Facsimile: 404 421 8930

"We are committed
to providing the
Quality
our customers expect."

SIEMENS

Siemens Energy & Automation, Inc.

An Atlanta-based manufacturer of electrical products and systems for homes, offices, industrial facilities and utilities.

If the control of electricity is critical to your business, the name is Siemens Energy & Automation.



Best Wishes



1240 Powers Ferry Rd., Marietta, GA 30067

(404) 955-6142

A division of Deloitte & Touche

Congratulations

DOVER ELEVATORS
DOVER ELEVATOR COMPANY

Sam M. Hughey, District Manager
2250 Northwest Parkway, Suite E
Marietta, Georgia 30067
(404) 916-0555, Ext. 225
Fax (404) 859-9688

Cobb Parkway Exxon

405 Cobb Parkway South
Marietta, Georgia 30062
424-6741

Congratulations Graduates



Wm. (Bill) Cox III
Vice-President

11 Atlanta Street
Marietta, GA 30060
(404) 428-2182
Fax (404) 428-6230

Anna R. Cabik
President

ANATEK, INC.
Contractor/Steel Erector

1513 Johnson Ferry Road • Suite B-20
Marietta, Georgia 30062
(404) 971-2238 • Fax (404) 977-9489



Canon

6971 Peachtree Industrial Blvd. (404) 448-0770
Norcross, Georgia 30092 Fax (404) 447-0716



**SOUTHLAND
HOME BUILDERS**

265 N. Cobb Parkway • Marietta, Georgia 30062

"Custom Crafted, Your Plans or Ours"
6 Georgia Locations
Call 1-800-964-HOME for a free catalog



Packaging & Material Handling Systems

850 Mountain Industrial Dr.
Marietta, GA 30060 - 7908
(404) 424-9784
Fax (404) 424-8392



OF MARIETTA, INC.

810 South Cobb Parkway
Marietta, Georgia 30062
(404) 422-1100

BILL RUSK

Since 1964



FRASER FLORIST & GIFTS
FLOWERS FOR ALL OCCASIONS

973-3780 1523 LOWER ROSWELL ROAD, NE
MARIETTA, GEORGIA 30068

Products and services that enhance
productivity for users of personal computers
and workstations.

DCA

Digital Communications Associates Inc., 1000 Alderman Drive, Alpharetta, GA 30202-4199

BENNY LLAMAZALES

Liamas Coatings Inc.

P.O. Box 351

Douglasville, GA 30133

(404) 799-0384

LAMAS

Industrial Painting and Decorating Contractors
Sandblasting & High Pressure Waterblasting
Atlanta • Orlando • Tampa

GOODYEAR

KWIK-FIT TIRE & SERVICE, INC.
1017 Roswell Street
Marietta, Georgia 30060

(404) 427-5316

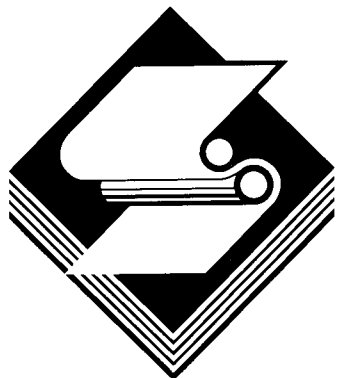

Stevens Graphics

*If Career Development Is Important
To You, Consider Stevens Graphics!*

For a free copy of our Career
Information brochure, write today!

Stevens Graphics
Human Resources Dept.
713 R.D. Abernathy Blvd.
Atlanta, Georgia 30310
An Equal Opportunity Employer M/F

MUNICIPAL ELECTRIC AUTHORITY OF GEORGIA
GEORGIA'S PUBLIC POWER



Providing low-cost,
dependable
electric energy to
48 Georgia
communities.

1470 Riveredge Parkway, N.W., Atlanta, GA 30328-4640
404/563-0300
EOE/M-F



MURATA ERIE NORTH AMERICA

Murata Erie North America, Inc.
2200 Lake Park Drive
Smyrna, GA 30080

(Sub. of Murata Mfg. Co. Ltd. - Japan) A
world leader in the manufacture of elec-
tronic ceramic capacitors and related
piezo and high voltage devices.
Employs: 1,800 Recruits: Nationally.
Robert L. Entekin, V.P. Human
Resources, Tel. (404) 436-1300



950 HUDSON ROAD
MARIETTA GA 30060
(404) 425-8193

"Just a Walk Away"

Piccadilly Cafeteria

536 Cobb Parkway, S.E.
Marietta, Georgia 30062
(404) 422-7121

11:00 to 8:30 Continuous Service / Take Out Available



SLATER • PAULL & ASSOCIATES, INC.
1850 PARKWAY PLACE • SUITE 300
MARIETTA, GEORGIA 30067
(404) 424-8833
FAX (404) 424-4655

Architecture Preservation
Interior Design

Land Planners, Engineers & Surveyors

Walt Rodenberger
Civil Engineer



Rodenberger & Associates, Inc.
2130-C Kingston Court
Marietta, Georgia 30067
(404) 956-1070 Fax 952-7710



BEARINGS & DRIVES, INC.
668 Eleventh Street N.W.
Atlanta, Georgia 30318
Tele: 404-875-9305

FBA

FRANK BETZ ASSOCIATES, INC.
1800 LAKE PARK DRIVE/SUITE 101
SMYRNA, GA 30080
404/431-0888

Ruhling & Ruhling - Land Surveyors
RUSTY RUHLING

2690 B Summers Street, N.W.
Kennesaw, Georgia 30144
(404) 422-8768

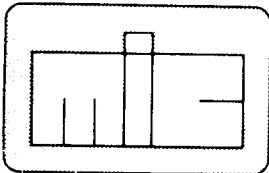

**MECHANICAL
INDUSTRIES COUNCIL**

1950 Century Blvd. • Suite 5
Atlanta, GA 30345
(404) 633-9811



Marietta Flower Shop
Flowers for all Occassions

789 Roswell St.
Marietta, GA 30060

(404) 422-4122
1-800-688-4122

CHAPMAN COYLE CHAPMAN
ARCHITECTS

CHAPMAN COYLE CHAPMAN & ASSOCIATES ARCHITECTS AIA, INC.
1225 JOHNSON FERRY ROAD, BUILDING 800, MARIETTA, GEORGIA 30068
404-973-6644 FAX 404-529-9864

U. S. MILLWRIGHTS
P. O. BOX 798
MARIETTA, GEORGIA 30061

SCOTT IRVIN
VICE-PRESIDENT

PHONE (404) 424-8624

'MASTER RIGGERS'

LORAL
INFORMATION DISPLAY SYSTEMS

A DIVISION OF LORAL CORPORATION
675 Peachtree Industrial Blvd.
Atlanta, Georgia 30360
404/448-1604

Seeking: Digital Microprocessor Based/Hardware &
Software Design Engineers and Analysts



WELKER & ASSOCIATES, INC.
CONSULTING ENGINEERS

COMPLETE CIVIL, SANITARY AND
ELECTRICAL DESIGN & CONSTRUCTION
MANAGEMENT

P. O. BOX 937, MARIETTA, GEORGIA 30061
(404) 422-1902

Best Wishes
Class of 94
from

LANIER

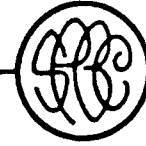

SWEETWATER PAPER BOARD
COMPANY, INC.

Manufacturers of Paperboard for the
Building and Packaging Industries

5700 Paper Mill Road
Austell, GA 30001
(404) 944-9350

A CARAUSTAR INDUSTRIES Company

Compliments of
KYSOR//WARREN
DIVISION OF KYSOR INDUSTRIAL CORPORATION

Columbus, GA
(404) 568-1514

Conyers, GA
(404) 483-5600

*Division of Kysor Industrial Corp.
Refrigeration Systems & Display Cases
For The Supermarket Industry*



**COMMUNICATION
MEANS THE WORLD
TO US!**

**Scientific
Atlanta**





KNOX ELECTRICAL CONTRACTORS, INC.
 411 Barber Road
 Marietta, Georgia 30060
 (404) 422-9857

Larry E. Knox, President

PECHTER & ASSOCIATES, P.C.
 CERTIFIED PUBLIC ACCOUNTANTS
 200 Galleria Parkway, Suite 880
 Atlanta, Georgia 30339

MARVIN PECHTER
 Certified Public Accountant

Fax (404) 850-8901

Bus. (404) 850-8808

Res. (404) 394-4198



MICHAEL E. SIMS
 Phone (404) 436-0516
SIMS & SONS CONSTRUCTION, INC.
 4578 Pine Street
 Smyrna, GA 30080

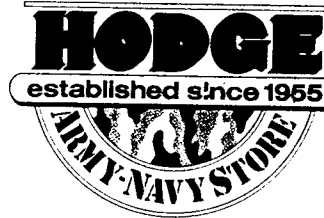

507 Cobb Parkway SE
 Marietta, Georgia 30062
 (404) 427-9331

A Million & 1 Items



Wometco Cable TV
 of Cobb County

(404) 427-0010

1145 Powder Springs Road • Marietta, Georgia 30064

PHONE (404) 427-4278
 WATS 1-800-277-4278
 FAX (404) 427-3282

Bolden DIE SUPPLY COMPANY
 TOOLING AND PRODUCTION SUPPLY SPECIALISTS

189 Cobb Parkway
 P.O. Box 6566
 Marietta, Georgia 30065

ALLEN L. HOTT
 PRESIDENT

HABASIT BELTING, INC.
 3453 Pierce Drive
 P.O. Box 80507
 Chamblee (Atlanta) GA 30366
 Telephone (800) 458-6431
 Telefax (800) 422-2748



Power transmission
 and conveyor belts

OFFICE (404) 941-0020

HOME (404) 834-4389

TRI TECH, INC.
 A METAL PRODUCTS COMPANY
 FABRICATORS

DARRELL STORY
 PRESIDENT

5710 HARRISON AVE.
 AUSTELL, GEORGIA 30001



ARCHITECTURAL
 INDUSTRIAL
 REHABILITATION
 INVESTIGATIONS
 ANTENNAS

STARZER & RITCHIE, INC.
 CONSULTING STRUCTURAL ENGINEERS

HUBERT STARZER, P.E.
 PRESIDENT

2323 PERIMETER PARK DRIVE
 SUITE 100, ATLANTA, GEORGIA 30341
 (404) 455-3404 FAX (404) 451-1415

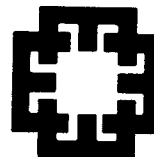

ENGINEERING CONSULTANTS
 NUCLEAR POWER INDUSTRY

ENERCON SERVICES, INC.

1600 Parkwood Circle
 Suite 600
 Atlanta, GA 30339-2119

(404) 980-2360
 (800) 733-1345
 FAX (404) 980-2386

HATCHER & SON CONSTRUCTION, INC.
 GENERAL CONTRACTORS & CONSTRUCTION CONSULTANTS

B.J. HATCHER
 PRESIDENT

2399 N. CHURCH LANE S.E.
 SMYRNA, GEORGIA 30080

OFFICE - 794-6009

JOBS JOBS JOBS
 ENTER THE JOB MARKET • OBTAIN PROFESSIONAL EXPERIENCE



MARIETTA
 2000 Powers Ferry Rd.
 Suite 2-B
 Marietta, GA 30067
 956-1900

ROSWELL
 861 Holcomb Bridge Rd.
 Suite 102
 Roswell, GA 30076
 998-6158



*Working with
Southern Tech
to build a
better future*

JOHN PORTMAN & ASSOCIATES
Architects & Engineers

231 Peachtree Street, N.E.
Suite 200
Atlanta, Georgia 30303
(404) 614-5555

SCHOLASTIC ADVERTISING, INC.

Advertising Specialists
and Consultants

Providing professional sales
and service support for
University and
College Yearbooks

Two offices to serve you:

In the East
Call 1-800-964-0777
In the West
Call 1-800-964-0776

Mark E. Hayden

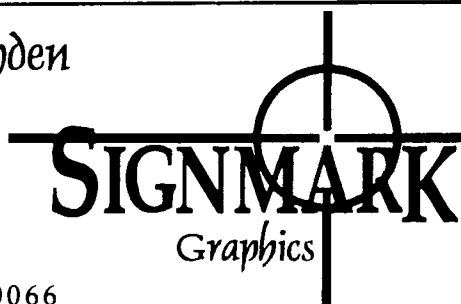

Marietta, GA 30066

(404) 427-3227

Marietta Pawn Brokers, Inc.
602 ATLANTA ST. S.E.
MARIETTA, GA. 30060

WE BUY GOLD & SILVER



**GENUINE PARTS
COMPANY**

BILL JENKINS
Store Manager

Marietta Branch
785 S. Marietta Pkwy.
Marietta, GA 30060
(404) 428-1551



Michael E. Martin
Account Executive

Apple Computer, Inc.
1100 Abernathy Road, Suite 1800
Atlanta, Georgia 30328
404 551-4707
Fax: 404 551-4710
AppleLink: ME.MARTIN



*The People To Trust With The
Most Important Part Of Your Car.*
Find the location nearest you in the yellow pages.

FLUID POWER SOUTH INCORPORATED

JOHN CRAWFORD WELLS, SR
PRESIDENT

2065 PEACHTREE INDUSTRIAL COURT
CHAMBLEE, GEORGIA 30341

AC- 404-455-8718
Cellular AC-404-316-2411

PORTRAIT

INDEX

Acreman, Shannon	60	Burchall, Myron	62
Agushamais, Ehab	48	Burton, Stan	50
Albritton, Kyle	50	Butler, Andrew	62
Aleman, Samuel Jr	60	Cantrell, Doc	62
Ali, Rahim Kassam	60	Cardona, Pablo	62
Amason, Bitsy	60	Carter, Scott	63
Arain, Sinan	60	Cato, Kassia	50
Armstrong, James	60	Childers, Derrick	63
Arnold, Robert	60	Clifford, Travis	63
Azam, Amir	60	Coleman, Lee	51
Badii, Armin	48	Collins, Phil	63
Baierle, Rob	60	Connell, Charles Jr	63
Bailey, Michele	61	Cordell, Tim	63
Bailey, Robert	50	Cornwell, Kimberly	51
Bartley, Kevin	61	Cox, David	63
Baskin, Adrian	61	Cox, Ed	63
Bennett, Chris	61	Crossley, Cassie	63
Bingham, Morris	61	Csanaadi, Thomas Jr	63
Blumenthal, Matthew	61	Cutcliff, David	51
Bonilla, Ricardo	61	Dansburg, Chris	64
Boros, Leigh A	61	Davis, Curt	64
Britt, Mitch	62	Day, Laree	51
Brown, Douglas	50	Denmark, Tonya	64
Brown, Flounder	62	Denton, Keith	64
Brown, Robert	48	DeSloover, Edward	64
Brown, Shawn	62	Desta, Mira	64
Bryant, Johnny	50	Diaby, Souleymane	64
buchanan, Joshua	62	Driggs, Clark	64
Buhl, Bob	50	Dun, James	64
		Dunham, Tyron	51
		Edwards, Gail	51
		Edwards, Nathan	64
		Elbaff, Riyadh	65
		Elliott, Elizabeth	51

Elliot, Paul	65	Harrell, Mark	68
Ellison, Natasha	51	harris, Stephanie	68
Endirias, Hezekiah	65	Harrison, Kevin	68
English, Craige	65	Hayes, Kevin	52
Fain, Kenneth	65	Heath, John	68
Ferrell, Alejandro	65	Hefner, Shawn	68
Ferry, Gay	52	Hinson, Martin	52
Fields, David	65	Hoawell, Nicola	69
Fisher, Kendall	52	Holmes, Gerald	69
Foster, Brian	65	Holton, Leigh	69
Foster, Macy	66	Hug, Isan	69
Galli, Dallas	66	Hutchison, Hutch	69
Gangasani, Sukanya	48	Ivie, Heath	69
Ghebreyesus, Teodros	66	Jackson, Dennis	69
Giles, Arron	66	Jarnagin, Wendy	69
Gill, David	66	Jassar, Waaseem	49
Gorman, David	66	Jefferson, Roxanna	69
Gosnell, Kenneth	67	Johnson, Christopher	69
Gospodareck, Louis	67	Johnson, Latanya	69
Gouger, Harry	67	Johnson, Robert	70
Grady, Paul	52	Johnston, William	70
Greene, Dana	67	Joiner, Raymond	70
Greene, Stephanie	67	Jones, John	53
Griggs, Marcia	67	Jordan, Travis	70
Grisson, Jeanna	68	Jorio, Yassir	53
Guzman, Christopher	68	Karrazzi, Zakk	70
Hadjimirzaei, Kourosh	52	Keels, Thomas	70
Hamby, Jon	68	Kelley, David	70
Hammontree, Tera	68	Kennedy, Cedric	70
Hampton, Derek	68	Kennington, Brian	70
Hardin, Randall	52	Kim, Sunny	70
Harford, Bo	68	Kiser, Daryl	53
Harper, Mickey	68	Koptis, Jennifer	53
Harper, Wendy	52		

Kurz, Scott	70	Middleton, Angela	55
Labbe, Lawrence	70	Miller, Mark	73
Lane, Mari	71	Mize, Karen	55
Lawson, Charles	49	Moran, James	73
Leboy, Melinda	70	Morgan, Robby	73
Leftwich, Kevin	70	Morse, Rich	55
Liangill, Kevin	53	Munder, Eric	73
Lindsey, Tyler	53	Nagarkar, Vinnie	55
Little, Kimberly	53	Nelson, David	55
Locklear, Chad	71	Nichols, Brandon	55
Lockridge, Russell	71	Oakes, David	73
Long, Jason	71	Oglesbee, Gene Jr	73
Lorenzo, Eddie	71	Oliver, Tracy	55
Lumpkin, Travis	71	O'Brien, Jim	55
Mackey, Makario	72	Orishanivi, Johnson	73
Maddox, Sharon	72	Ortiz, Nestor	73
Madison, Louis Jr	72	Osborn, Denise	73
Madjid, Ait-yahia	54	Otey, Stephen	73
Madrerohon, Charles	72	Oveton, Brian	73
Maness, Legrand Jr	72	Ownby, James	73
Mann, John	49	Pajores, Osear	74
Maurone, Charles	54	Patterson, Nathan	74
May, Alex	54	Payne, David	74
May, Patrick	72	Pearce, Eric	56
Mays, Kafi	72	Perez, Tony	56
McCord, Joe	72	Perides, Angie	74
McKinnney, Charmaine	72	Phillips, Patrick	56
McLeRoy, Dee	72	Pickle, Chris	56
McQuagge, Stuart	72	Pincilla, Rosita	74
McWhorter, Edward	54	Plumlee, David	74
Mederis, Alfred	54	Pontier, Matthew	74
Meitz, Jon	72	Porter, Shanna	56
Melillo, Mike	54	Powell, Boysie III	74
Merrell, Clint	73	Power, David	74

Poyce, Shimada	74	Smith, Derrick	77
Price, Carl	49	Smith, James	78
Purcell, Kevin	74	Smith, Ray	78
Quattlebaum, Joshua	75	Sorensen, Brian	57
Quijano, Michael	75	Sterling, Robert	78
Raupp, Harry	75	Stewart, Charless	57
Raza, Choudhary	75	Stewart, William	78
Reese, Michael	75	Stover, Jeremy	78
Redwine, Jacob	75	Stowers, Rebecca	78
Riggs, Arrow	56	Studevart, Mirhonda	78
Rivera, Jimmy	56	Stuler, Wayne	78
Rowe, Lee	57	Taylor, Orin	79
Rogers, Chante'	76	Temple, Brent	79
Roman, Marcus	76	Thibodeau, Rob	79
Rowe, Derrick	76	Thigpen, Lamar	58
Rud, Larry	76	Thomas, Edward	79
Russell, Vaughn	76	Thomas, Julie	58
Saaenz, Michelle	76	Tidd, Bryan N	58
Scales, James	57	Tirevold, Greg	79
Scheufler, David	76	Touchstone, Rob	79
Schmidt, Jason	76	Trotochaud, Timothy	58
Schuler, John	76	Truett, Allen	79
Scott, Joe	76	Tunget, Joe	79
Seals, LaToya	76	Usserey, Jonathan	79
Seo, Juhyon	76	Vaghmar, Jamir	79
Shaikh, Irfan	77	Vashi, Miki	79
Shannon, Bretina	57	Wade, Mary	58
Shelton, Kenneth	77	Wade, Robert	79
Shipman, Chris	77	Wages, Scott	58
Siddiqui, M Imran	77	Wagstaff, Robin	80
Sims, Alexandria	57	Waldo, Todd	80
Smith, Brian	77	Walker, Julian	80
Smith, Chad	77	Waller, Jennifer C	58
Smith, Charles	77	Walton, Mark	80

Watkins, Anthony	80
Webster, Kevin	80
Wells, Sean	80
West, Chinika	80
West, Edward	58
Weldon, Michael	59
Weston, Bill	80
Wetherington, Cary	59
White, Jennifer	80
Whitfield, Ben	80
Whitehead, Michael	59
Whitfield, Ben	80
Wibowo, Johanes	49
Wiggins, John	80
Wiggins, Tony	59
Wilkes, Jay	81
Wilkey, Ronald	81
Willis, Andre'	81
Wolfe, Scott	81
Wood, Charles	59
Woodall, Kelly	59
Wysong, Brian	81

Bill Finnick

If a Yearbook is a collection of the memories we shared this year I already know some things I will miss. First I'll miss being close to the main campus. But the new South Campus for the Civil Department is going to be so nice I'll get over it real soon.

All of the professors in the CET department have been great, if you don't believe me just ask some of them, but my first challenging CET class was taught by Professor Patrick Pherson. He left to go help provide clean drinking water to the people of Ethiopia with SIM, a missionary group. He had a style of teaching which enlightened the student's mind that is a premium at any technical school.

The end of school brings graduation and other forms of forced separation from the students that have grown to be your friends. When Ed leaves this summer the whole *Sting* staff I started with will be gone. Shanna Fernandez and Beth Elliot have both graduated and moved on to the real world. But the friend I think I will miss the most will be [Psyco] Dave Conrad. A Prince in the kingdom of friends there are so few as loyal. I know I'll miss him, if nothing else, for how he kept things exciting.

Congratulations Kassia it's done.
See you next year Phil.

How do you pronounce Jarred's last name?

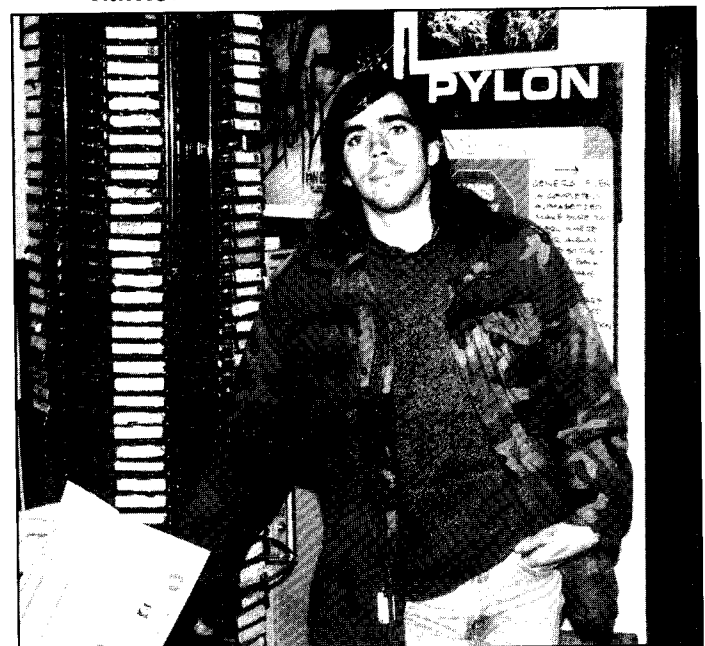
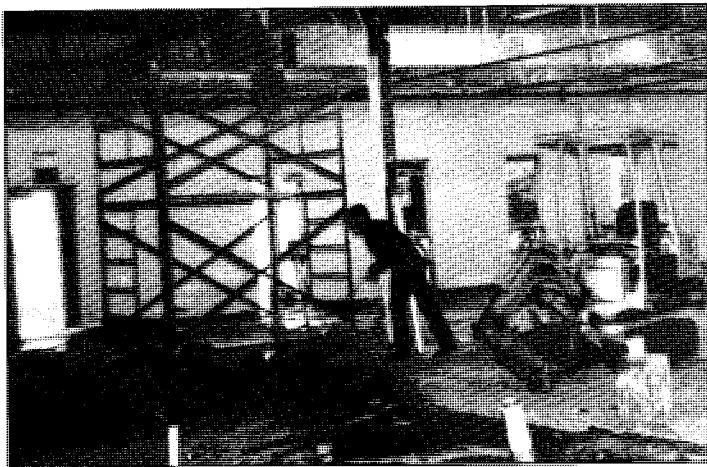
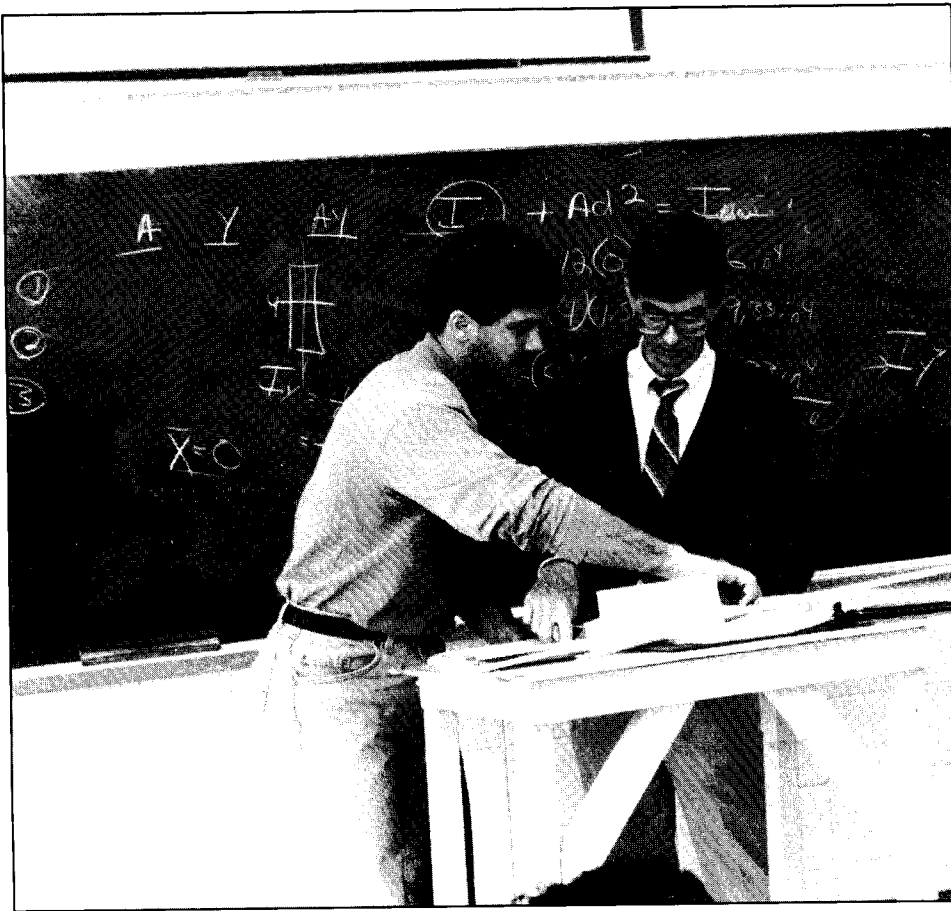

THE TECHNICIAN'S LOG
SOUTHERN COLLEGE OF TECHNOLOGY
1100 SOUTH MARIETTA PARKWAY
MARIETTA, GEORGIA 30060

1993-1994
LOG STAFF

EDITOR:
Kassia Cato

ASSISTANT EDITOR:
Phil Collins

PHOTOGRAPHERS:
Leigh Boros
David Conrad
David Dula
Jarred Fehr
Bill Finnick
Sharon Maddox
Tony Perez

STAFF MEMBERS:

Jennifer Bige	Jarred Fehr	Ed Hardy
Leigh Boros	Shanna Fernandez	Bryan Tidd
David Conrad	Bill Finnick	Tonyel Stewart
David Dula	Bill Greve	Jen Waller

LOG SPECIFICATIONS

SIZE	9 X 12
PAGES	176
COPY	12 and 14 pt. Palatino
HEADLINES	Palatino SMALL CAPS
PRESS RUN	1,105
PRINTER	WALSWORTH PUBLISHING CO.
REPRESENTATIVE	Mary Kay Kimmitt
ADVISOR	Barry Birckhead